

REMER

RUBINETTERIE



2021-22
LISTINO PREZZI MINUTERIA
MINUTERY PRICE LIST

2021-22

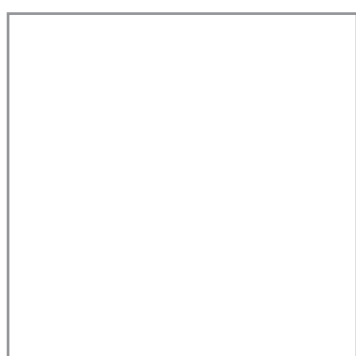

REMER

RUBINETTERIE



**LISTINO PREZZI
MINUTERIA**

***MINUTERY
PRICE LIST***

L'AZIENDA - THE COMPANY

REMER
RUBINETTERIE

La forza di un grande Gruppo - <i>The strength of a big Group</i>	pag 4
L'azienda - <i>The Company</i>	pag 5
Tutta la forza del Made in Italy - <i>The made in Italy starts here</i>	pag 6
I nostri stabilimenti produttivi - <i>Our production plants</i>	pag 7

FLESSIBILI - FLEXIBLE HOSES



Flessibili DN6 acciaio inox <i>Stainless steel DN6 flexibles</i>	pag 18	Flessibili antivibranti inox <i>Stainless steel anti-vibration flexibles</i>	pag 30
Flessibili DN8 acciaio inox <i>Stainless steel DN8 flexibles</i>	pag 20	Tubi di rame <i>Copper tubes</i>	pag 32
Flessibili DN10 acciaio inox <i>Stainless steel DN10 flexibles</i>	pag 23	Adattatori per flessibili <i>Flexible hoses adapter</i>	pag 32
Flessibili DN13 acciaio inox <i>DN13 flexibles stainless steel</i>	pag 26	Raccordi e nipples <i>Connections and nipples</i>	pag 33
Flessibili antivibranti <i>Anti-vibration flexibles</i>	pag 28		

MINUTERIA - MINUTERY



Rubinetti sottolavabo <i>C.P. Brass angle valve</i>	pag 36	Galleggianti <i>Flushing valves</i>	pag 40
Rosette <i>Wall flanges</i>	pag 38	Rubinetti <i>Taps</i>	pag 41
Canotti, raccordi e tubi <i>Tubes and connectors</i>	pag 39	Accessori per lavatrice <i>Washing machine accessories</i>	pag 44
Passo rapido <i>Flushing valves</i>	pag 40		

VALVOLE - VALVES



Serie Seven <i>Seven series</i>	pag 48	Serie Reduce Flow <i>Reduce Flow series</i>	pag 54
Serie RR <i>RR series</i>	pag 49	Valvole <i>Valves</i>	pag 55
Serie Full Flow <i>Full Flow series</i>	pag 50	Serie Yellow <i>Yellow series</i>	pag 59
Serie Standard <i>Standard series</i>	pag 52		

RACCORDERIA - FITTINGS



Raccordi in ottone <i>Brass fittings</i>	pag 65	Tubo multistrato RR PEX <i>Multilayer pipe RR PEX</i>	pag 70
Viti doppie <i>Double nipples</i>	pag 68	Analisi del tubo multistrato RR PEX <i>Analysis of the multilayer pipe RR PEX</i>	pag 71
Portagomma <i>Hose holder</i>	pag 68	Serie 490 <i>490 series</i>	pag 72
Raccordi <i>Fittings</i>	pag 69	Accessori per radiatori <i>Radiator accessories</i>	pag 73
Raccordi in acciaio zincato <i>Galvanized fittings</i>	pag 69	Accessori per tubi <i>Accessories for pipes</i>	pag 75
Serie 495 <i>495 series</i>	pag 70		

ACCESSORI - ACCESSORIES



Rubinetti <i>Faucets</i>	pag 78	Accessori per lavabo <i>Wash basin accessories</i>	pag 88
Cartucce <i>Cartridges</i>	pag 78	Accessori per lavello <i>Sink accessories</i>	pag 88
Deviatori <i>Diverter</i>	pag 80	Accessori per WC ed orinatoio <i>WC and orinals accessories</i>	pag 89
Prolunghe <i>Extensions</i>	pag 80	Accessori per doccia <i>Shower accessories</i>	pag 90
Deviatori automatici <i>Automatic diverters</i>	pag 80	> Canaline sifonate rettangolari <i>Rectangulars floor drains</i>	pag 90
Vitoni <i>Headvalves</i>	pag 81	> Pilette sifonate <i>Siphon drains</i>	pag 91
Linea risparmio idrico <i>Water saving line</i>	pag 82	> Copertura a pavimento in acciaio inox <i>Stainless steel floor drains</i>	pag 91
Riduzioni <i>Reduction</i>	pag 83	> Sifoni antiscaraffaggio <i>Anti cockroach-insect trap</i>	pag 91
Aeratori <i>Aerators</i>	pag 84	Scarichi automatici <i>Pop-up wastes</i>	pag 92
Eccentrici <i>Eccentrics</i>	pag 85	Scarichi automatici click-clack <i>Automatic click-clack pop-up wastes</i>	pag 92
Colonne bordo vasca <i>Vertical connections for bath mixer</i>	pag 85	Sifoni <i>Traps</i>	pag 94
Bocche <i>Spouts</i>	pag 86	> Sifoni salvaspazio <i>Space-saving traps</i>	pag 95
Supporti doccia <i>Hand shower supports</i>	pag 87	Colonne di scarico <i>Bath wastes</i>	pag 96
Scarichi <i>Wastes</i>	pag 87	Accessori per scaldabagno <i>Water heater accessories</i>	pag 97

COMPONENTI PLASTICI - PLASTIC COMPONENTS



Componenti plastici <i>Plastic components</i>	pag 100
--	---------

La forza di un grande Gruppo - The strength of a big Group

Pulitura, Controllo qualità, Pre-assemblaggio, Stampaggio plastico, Logistica.
 Polishing department, Test department, Pre-assembly department, Injection plastic pressing department, Logistic department.



ENGINEERING 2
 Produzione high-tech
 High-tech production.



ENGINEERING 1
 Produzione high-tech
 High-tech production.



Sede operativa e uffici amministrativi
 Head office and factory.



Produzione flessibili
 Flexible hoses production.



REMER

RUBINETTERIE

Remer Rubinetterie nasce a Milano nel 1965 ed è oggi un'imponente realtà produttiva sita a Cassano d'Adda (MI) su un'area di circa 85.000 mq. L'impegno continuo nel crescere, investire, ideare, creare e perfezionarsi è da sempre il motore trainante dell'azienda che si è confermata negli anni come un solido punto di riferimento nella produzione di rubinetteria e minuteria idraulica in Italia e nelle 120 Nazioni estere in cui distribuisce attivamente il proprio prodotto.

Ogni articolo di Remer Rubinetterie esprime il lavoro e la passione di un team di personale qualificato e motivato da una filosofia aziendale di continuo miglioramento. L'offerta a catalogo apre un ampio ventaglio di rubinetteria per bagno e cucina: linee di rubinetteria dai design più innovativi alle forme tradizionali; soluzioni wellness per gli interni doccia; prodotti ad alto contenuto tecnologico per la temporizzazione, la miscelazione termostatica e la cromoterapia; complementi di arredo bagno; cartucce, minuteria, raccorderia, flessibili e materiale idraulico. Ogni articolo prodotto è pensato e realizzato per garantire uno standard qualitativo elevato, costante e duraturo nel tempo.

La grande varietà dell'offerta è un punto chiave nella proposta al Cliente che trova in Remer Rubinetterie un'azienda in grado di fornire, in aggiunta ad una rubinetteria di alta qualità, una notevole scelta di prodotti per l'impiantistica idraulica con un ottimo rapporto qualità/prezzo.

Remer Rubinetterie born in Milan in 1965 and is today an impressive production facility located in Cassano d'Adda (Milan, Italy) on an area of about 85,000 square meters. The continuous commitment to grow, invest, design, create and improve has always been the driving force of the company which has confirmed itself over the years as a solid reference point in faucets and hydraulic small parts manufacturing, in Italy and in 120 foreign countries in which actively distributes its product.

Each Remer Rubinetterie item expresses the work and the passion of a team of qualified personnel motivated by a company philosophy of continuous improvement. The catalogue of Remer Rubinetterie offers up a wide range of bathroom and kitchen faucets: complete faucet collections from the most innovative designs to traditional shapes; wellness solutions for shower interiors; high-tech products for timed flow taps, thermostatic mixing and chromotherapy; bathroom accessories; cartridges, small parts, fittings, flexible hoses and hydraulic material. Each product is designed and manufactured to guarantee a high, constant and long-lasting quality standard.

The huge variety of the offer is a key point in our proposal to the Customer who finds in Remer Rubinetterie a Company able to supply, in addition to high quality faucets, a considerable choice of products for hydraulic systems with an excellent quality / price ratio.



LE NOSTRE CERTIFICAZIONI:

Remer Rubinetterie S.p.A. è un'azienda certificata UNI EN ISO 9001:2008 sistema di gestione qualità aziendale e UNI EN ISO 14001: 2004 per l'impatto ambientale.



OUR CERTIFICATIONS:

Remer Rubinetterie S.p.A. is a UNI EN ISO 9001:2008 certified factory for the quality system and UNI EN ISO 14001: 2004 for environmental impact.

Remer Rubinetterie S.p.A.
Via Leonardo da Vinci, 83
20062 Cassano d'Adda (MI) Italy
Tel. +39 0363 364 211
E-Mail: info@remer.eu



www.remer.eu



@remerrubinetterieofficial



#remerrubinetterie



Remer Rubinetterie



Remer Rubinetterie

Tutta la forza del Made in Italy - The made in Italy starts here



Il Gruppo Remer è da sempre alla ricerca di sviluppo e tecnologia e soprattutto negli ultimi anni questo processo ha avuto un incremento notevole che ha portato alla nascita di nuovi stabilimenti di produzione con lo scopo di accentrare tutte le fasi produttive. All'interno del nostro gruppo si trovano macchinari di ultima generazione che permettono di realizzare il prodotto finito.

Parliamo di cicli completi che vanno dalla progettazione alla realizzazione dei manufatti, tutto all'interno dei nostri stabilimenti.

Possiamo elencare i nostri macchinari più sofisticati quali (ma non solo):

- centri di lavoro con robots,
- centri di lavoro con visori ottici e robots,
- transfer a 3 assi,
- transfer a doppia barra
- torni con caricatori,
- macchinari per il taglio barra piena o forata e in tubo,
- macchinari per il taglio tubi e lavorazione canotti e aste
- impianti per il taglio della lastra di ottone o altri metalli,
- grande dipartimento di stampaggio plastica con numerose macchine multimarca.

In più:

- grande area dedicata alla lucidatura e pulitura con numerosi impianti automatici robotizzati e sistemi manuali,
- grande impianto di cromatura ad alta qualità,
- dipartimento per la creazione di stampi,
- grande e sofisticata area test prodotto e controllo qualità,
- spettrometro per analisi materia prima,
- linee automatiche di confezionamento,
- impianti per insacchettamento in automatico,
- macchine taglio spugna,
- imballaggio in termoformato in automatico,
- linee automatiche di confezionamento.
- controllo e gestione della produzione e degli ordini totalmente automatizzata con stazioni pc e radio frequenza in tutti gli stabilimenti.

Remer Group has always been searching for innovation and technology and during the last few years this process had a remarkable acceleration that drove to the centralisation of all our production plants between Milan and Bergamo area, to group all our production phases and implement our logistics. Inside these plants there are the most sophisticated Italian last generation machineries that permit to manufacture until the finished product.

Therefore we are talking about a complete cycle that goes from the design to the finished product.

We can list our sophisticated machineries like (but not only):

- work stations with robots,
- work stations with optical viewers and robots,
- 3-ways transfers- several robotised and automatic polishing machines,
- double bar transfers,
- lathes with loaders,
- full bar and tube bar cutters,
- pipes cutters and machineries to process tubes and rods,
- brass plate or other metals cutters,
- forging and injection machines department.

Furthermore:

- robotised and automatic polishing machines,
- high quality chrome plating system,
- tooling and moulds creation laboratory,
- sophisticated testing quality control machinery departments,
- spectrometer for analysis of raw material,
- automatic packaging,
- automatic bagging systems,
- sponge-cutters,
- thermo format machines,
- automatic packaging systems,
- radio frequency automatic orders control in each department.



I nostri stabilimenti produttivi - Our production plants

Un ciclo produttivo automatizzato e interno alle aziende del gruppo Remer che permette di selezionare con cura le materie prime utilizzate e di seguire con attenzione ogni fase di lavorazione: dalla minuteria alla rubinetteria, dalla progettazione al prodotto finito.

An automated production cycle within the Remer Group Companies allows to carefully select each material and to carefully follow each stage of our manufacturing: from small parts to faucets, from design to finished product.



Grandi spazi completamente attrezzati con macchinari italiani di ultima generazione.

Large spaces fully equipped with the latest Italian machinery













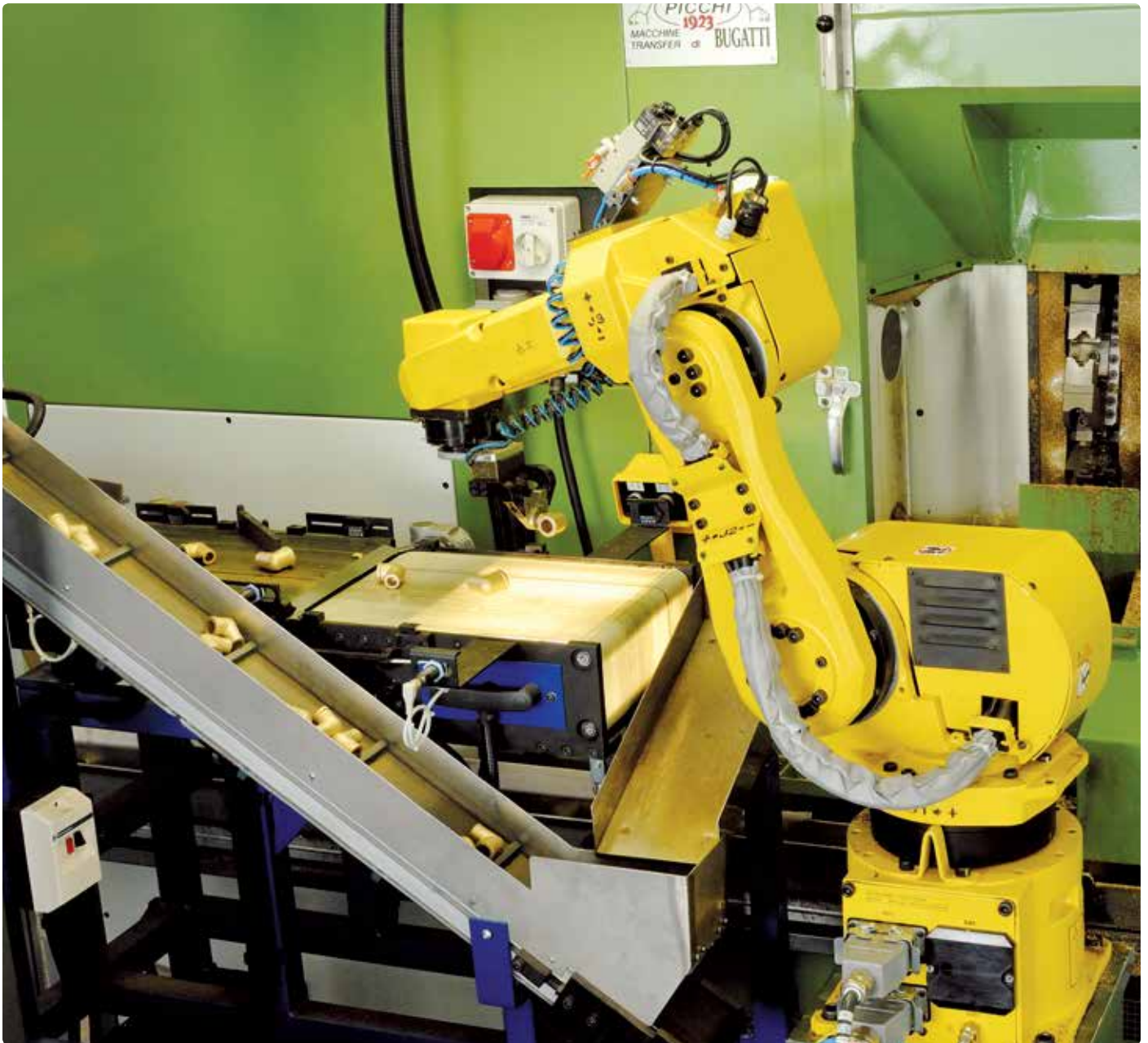







FLESSIBILI FLEXIBLE HOSES



FLESSIBILI - FLEXIBLE HOSES



FLESSIBILI
FLEXIBLE HOSES

MINUTERIA
MINUTERY

VALVOLE
VALVES

RACCORDERIA
FITTINGS

ACCESSORI
ACCESSORIES

COMPONENTI PLASTICI
PLASTIC COMPONENTS

FLESSIBILI DN 6 ACCIAIO INOX

FLESSIBILI PER RUBINETTERIA

STAINLESS STEEL DN 6 FLEXIBLES

FLEXIBLE HOSES FOR FAUCETS



DATI TECNICI - TECHNICAL DATA:

Tubo flessibile trecciato made in Italy in acciaio Inox AISI 304 con interno in gomma alimentare EPDM utilizzato per il collegamento tra la rete idrica e la rubinetteria sanitaria. Grazie alle dimensioni molto ridotte e alla pressatura su tutta la lunghezza della bussola, questo flessibile favorisce l'installazione su rubinetterie di qualsiasi design, specialmente quelle con un design molto minimale con degli spazi tecnici ridotti o poco accessibili. Tutti i flessibili sono raccordati con macchine automatiche ed il risultato è l'assoluta precisione di ogni pezzo prodotto per una garanzia di totale qualità.

Made in Italy braided hose in AISI 304 stainless steel with internal in non-toxic EPDM rubber, used for the connection between the water mains and the sanitary fittings. Thanks to the very small size and the pressing all along the entire length of the sleeve, this hose facilitates the installation on faucets of any design, especially on those with a very minimal design with reduced engineering spaces or not very accessible. All the hoses are produced with automatic machines and the result is the absolute precision of each produced piece for a total quality guarantee.

APPLICAZIONI - APPLICATIONS



MATERIALI - MATERIALS

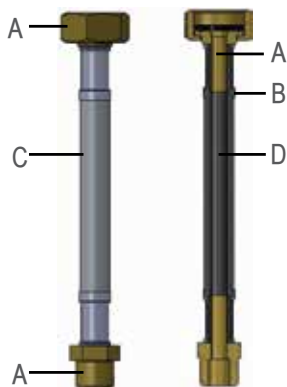

RACCORDI - FITTINGS:

- A) Ottone CW614N e CW617N nichelato o giallo
Brass CW614N and CW617N nickel plated or yellow

BUSSOLE - SLEEVES:

- B) Acciaio INOX AISI 304
Stainless steel AISI 304

TUBO - HOSE:

- C) Treccia 6 fili in acciaio INOX AISI 304
6 Wires Braid in steel INOX AISI 304
D) Tubo interno: gomma EPDM atossico
Internal pipe EPDM rubber, atoxic

CRATTERISTICHE - FEATURES



TEMPERATURA INSTALLAZIONE - INSTALLATION TEMPERATURE:

Da -5°C a +90°C - From -5°C to +90°C



PRESSIONE D'ESERCIZIO - WORKING PRESSURE:

10 BAR



PORTATA A 3 BAR - FLOW RATE AT 3 BAR:

19 lit/min



TEMPERATURA D'IMPIEGO - WORKING TEMPERATURE:

-5°C - +90°C



FORO MINIMO PASSAGGIO D'ACQUA - FITTING INNER DIAMETER:

4,7 mm



RAGGIO CURVATURA MINIMO - MINIMUM BENDING RADIUS:

25 mm



Ø INTERNO - INNER Ø:

Ø 6 mm



Ø ESTERNO - OUTER Ø:

Ø 10 mm

FLESSIBILI - FLEXIBLE HOSES

FLESSIBILI
FLEXIBLE HOSES

108P12F

Flessibile in Acciaio Inox AISI 304 - DN6 M10x1 - 1/2°F.
Stainless Steel Flexible hose AISI 304 - DN6 M10x1 - 1/2°F.

cm	20	25	30	35	40	45	50	60	80	100
€	2,60	2,80	2,90	3,00	3,20	3,40	3,50	3,70	4,20	4,80



108LP12F

Flessibile in Acciaio Inox AISI 304 - DN6 ML10x1 - 1/2°F.
Stainless Steel Flexible hose AISI 304 - DN6 ML10x1 - 1/2°F.

cm	20	25	30	35	40	45	50	60	80	100
€	3,30	3,40	3,60	3,70	3,80	3,90	4,10	4,30	4,90	5,30



MINUTERIA
MINUTERY

108P38F

Flessibile in Acciaio Inox AISI 304 - DN6 M10x1 - 3/8°F.
Stainless Steel Flexible hose AISI 304 - DN6 M10x1 - 3/8°F.

cm	20	25	30	35	40	45	50	60	80	100
€	2,60	2,80	2,90	3,00	3,20	3,40	3,50	3,70	4,20	4,80



108LP38F

Flessibile in Acciaio Inox AISI 304 - DN6 ML10x1 - 3/8°F.
Stainless Steel Flexible hose AISI 304 - DN6 ML10x1 - 3/8°F.

cm	20	25	30	35	40	45	50	60	80	100
€	3,30	3,40	3,60	3,70	3,80	3,90	4,10	4,30	4,90	5,30



VALVOLE
VALVES

1088D12F

Flessibile in Acciaio Inox AISI 304 - DN6 M8x1 - 1/2°F.
Stainless Steel Flexible hose AISI 304 - DN6 M8x1 - 1/2°F.

cm	20	25	30	35	40	45	50	60	80	100
€	2,70	2,80	2,90	3,00	3,30	3,40	3,50	3,70	4,20	4,80



108L8D12F

Flessibile in Acciaio Inox AISI 304 - DN6 ML8x1 - 1/2°F.
Stainless Steel Flexible hose AISI 304 - DN6 ML8x1 - 1/2°F.

cm	20	25	30	35	40	45	50	60	80	100
€	3,20	3,40	3,50	3,60	3,70	3,80	4,00	4,20	4,80	5,30



RACCORDERIA
FITTINGS

1088D38F

Flessibile in Acciaio Inox AISI 304 - DN6 M8x1 - 3/8°F.
Stainless Steel Flexible hose AISI 304 - DN6 M8x1 - 3/8°F.

cm	20	25	30	35	40	45	50	60	80	100
€	2,70	2,80	2,90	3,00	3,30	3,40	3,50	3,70	4,20	4,80



108L8D38F

Flessibile in Acciaio Inox AISI 304 - DN6 ML8x1 - 3/8°F.
Stainless Steel Flexible hose AISI 304 - DN6 ML8x1 - 3/8°F.

cm	20	25	30	35	40	45	50	60	80	100
€	3,20	3,40	3,50	3,60	3,70	3,80	4,00	4,20	4,80	5,30



ACCESSORI
ACCESSORIES

COMPONENTI PLASTICI
PLASTIC COMPONENTS

FLESSIBILI DN 8 ACCIAIO INOX

FLESSIBILI PER RUBINETTERIA E SANITARI

STAINLESS STEEL DN 8 FLEXIBLES

FLEXIBLES FOR FAUCETS AND SANITARIES



DATI TECNICI - TECHNICAL DATA:

Tubo flessibile trecciato made in Italy in acciaio Inox AISI 304 con interno in gomma alimentare EPDM utilizzato per il collegamento tra la rete idrica e la rubinetteria sanitaria o cassette W.C.e adatto a qualsiasi altro impiego sanitario. Tutti i flessibili sono raccordati con macchine automatiche ed il risultato è l'assoluta precisione di ogni pezzo prodotto per una garanzia di totale qualità.

Made in Italy braided hose in AISI 304 stainless steel with internal in EPDM rubber, used for the connection between the water mains and the sanitary fittings or W.C. flushing tanks. All the hoses are produced with automatic machines and the result is the absolute precision of each produced piece for a total quality guarantee.

APPLICAZIONI - APPLICATIONS



MATERIALI - MATERIALS

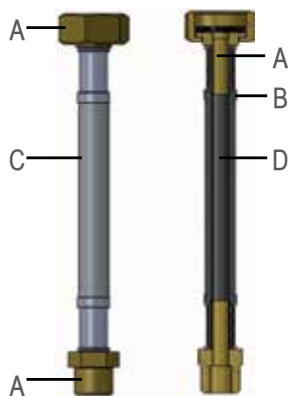

RACCORDI - FITTINGS:

- A) Ottone CW614N e CW617N nichelato
Brass CW614N and CW617N nickel plated

BUSSOLE - SLEEVES:

- B) Acciaio INOX AISI 304
Stainless steel AISI 304

TUBO - HOSE:

- C) Treccia 7 fili in acciaio INOX AISI 304
7 Wires Braid in steel INOX AISI 304
D) Tubo interno: gomma EPDM atossico
Internal pipe EPDM rubber, atoxic

CRATTERISTICHE - FEATURES



TEMPERATURA INSTALLAZIONE - INSTALLATION TEMPERATURE:

Da -5°C a +90°C - From -5°C to +90°C



PRESSIONE D'ESERCIZIO - WORKING PRESSURE:

10 BAR



PORTATA A 3 BAR - FLOW RATE AT 3 BAR:

29 lit/min



TEMPERATURA D'IMPIEGO - WORKING TEMPERATURE:

-5°C - +90°C

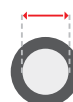

FORO MINIMO PASSAGGIO D'ACQUA - FITTING INNER DIAMETER:

6 mm



RAGGIO CURVATURA MINIMO - MINIMUM BENDING RADIUS:

30 mm



Ø INTERNO - INNER Ø:

Ø 8 mm



Ø ESTERNO - OUTER Ø:

Ø 12 mm

FLESSIBILI - FLEXIBLE HOSES

FLESSIBILI
FLEXIBLE HOSES

MINUTERIA
MINUTERY

VALVOLE
VALVES

RACCORDERIA
FITTINGS

ACCESSORI
ACCESSORIES

COMPONENTI PLASTICI
PLASTIC COMPONENTS



10812F

Flessibile in Acciaio Inox AISI 304 - DN8 M10x1 - 1/2°F.
Stainless Steel Flexible hose AISI 304 - DN8 M10x1 - 1/2°F.

cm	20	25	30	35	40	45	50	60	80	100
€	2,80	3,00	3,20	3,30	3,50	3,60	3,70	4,00	4,70	5,20



108L12F

Flessibile in Acciaio Inox AISI 304 - DN8 ML10x1 - 1/2°F.
Stainless Steel Flexible hose AISI 304 - DN8 ML10x1 - 1/2°F.

cm	20	25	30	35	40	45	50	60	80	100
€	3,30	3,40	3,50	3,70	3,80	3,90	4,10	4,40	5,00	5,50



10838F

Flessibile in Acciaio Inox AISI 304 - DN8 M10x1 - 3/8°F.
Stainless Steel Flexible hose AISI 304 - DN8 M10x1 - 3/8°F.

cm	20	25	30	35	40	45	50	60	80	100
€	2,80	3,00	3,20	3,30	3,50	3,60	3,70	4,00	4,70	5,20



108L38F

Flessibile in Acciaio Inox AISI 304 - DN8 ML10x1 - 3/8°F.
Stainless Steel Flexible hose AISI 304 - DN8 ML10x1 - 3/8°F.

cm	20	25	30	35	40	45	50	60	80	100
€	3,30	3,40	3,50	3,70	3,80	3,90	4,10	4,40	5,00	5,50



108XL12F

Flessibile in Acciaio Inox AISI 304 - DN8 MXL10x1 - 1/2°F.
Stainless Steel Flexible hose AISI 304 - DN8 MXL10x1 - 1/2°F.

cm	20	25	30	35	40	45	50	60	80	100
€	4,00	4,10	4,30	4,40	4,70	4,80	5,00	5,20	5,80	6,50



108XL38F

Flessibile in Acciaio Inox AISI 304 - DN8 MXL10x1 - 3/8°F.
Stainless Steel Flexible hose AISI 304 - DN8 MXL10x1 - 3/8°F.

cm	20	25	30	35	40	45	50	60	80	100
€	4,00	4,10	4,30	4,40	4,70	4,80	5,00	5,20	5,80	6,50



10812D12F

Flessibile in Acciaio Inox AISI 304 - DN8 M12x1 - 1/2°F.
Stainless Steel Flexible hose AISI 304 - DN8 M12x1 - 1/2°F.

cm	20	25	30	35	40	45	50	60	80	100
€	3,20	3,30	3,50	3,60	3,70	3,90	4,00	4,30	5,00	5,50



108L12D12F

Flessibile in Acciaio Inox AISI 304 - DN8 ML12x1 - 1/2°F.
Stainless Steel Flexible hose AISI 304 - DN8 ML12x1 - 1/2°F.

cm	20	25	30	35	40	45	50	60	80	100
€	4,20	4,40	4,50	4,80	4,90	5,10	5,20	5,50	6,00	6,70



10812D38F

Flessibile in Acciaio Inox AISI 304 - DN8 M12x1 - 3/8°F.
Stainless Steel Flexible hose AISI 304 - DN8 M12x1 - 3/8°F.

cm	20	25	30	35	40	45	50	60	80	100
€	3,20	3,30	3,50	3,60	3,70	3,90	4,00	4,30	5,00	5,50



108L12D38F

Flessibile in Acciaio Inox AISI 304 - DN8 ML12x1 - 3/8°F.
Stainless Steel Flexible hose AISI 304 - DN8 ML12x1 - 3/8°F.

cm	20	25	30	35	40	45	50	60	80	100
€	4,20	4,40	4,50	4,80	4,90	5,10	5,20	5,50	6,00	6,70



108TB

Flessibile in Acciaio Inox AISI 304 - DN8 M10x1 - TB10 mm.
Stainless Steel Flexible hose AISI 304 - DN8 M10x1 - TB10 mm.

cm	20	25	30	35	40	45	50	60	80	100
€	2,40	2,50	2,60	2,80	2,90	3,00	3,30	3,60	4,10	4,80



108LTB

Flessibile in Acciaio Inox AISI 304 - DN8 ML10x1 - TB10 mm.
Stainless Steel Flexible hose AISI 304 - DN8 ML10x1 - TB10 mm.

cm	20	25	30	35	40	45	50	60	80	100
€	2,70	2,80	3,00	3,20	3,40	3,50	3,70	3,90	4,50	5,20

10812F12F

Flessibile in Acciaio Inox AISI 304 - DN8 1/2°F - 1/2°F.
Stainless Steel Flexible hose AISI 304 - DN8 1/2°F - 1/2°F.

cm	20	25	30	35	40	45	50	60	80	100
€	3,30	3,50	3,60	3,70	3,90	4,00	4,20	4,40	5,10	5,70

**10812M12F**

Flessibile in Acciaio Inox AISI 304 - DN8 1/2°M - 1/2°F.
Stainless Steel Flexible hose AISI 304 - DN8 1/2°M - 1/2°F.

cm	20	25	30	35	40	45	50	60	80	100
€	3,30	3,50	3,60	3,70	3,90	4,00	4,20	4,40	5,10	5,70

**10838F38F**

Flessibile in Acciaio Inox AISI 304 - DN8 3/8°F - 3/8°F.
Stainless Steel Flexible hose AISI 304 - DN8 3/8°F - 3/8°F.

cm	20	25	30	35	40	45	50	60	80	100
€	3,30	3,50	3,60	3,70	3,90	4,00	4,20	4,40	5,10	5,70

**10838M38F**

Flessibile in Acciaio Inox AISI 304 - DN8 3/8°M - 3/8°F.
Stainless Steel Flexible hose AISI 304 - DN8 3/8°M - 3/8°F.

cm	20	25	30	35	40	45	50	60	80	100
€	3,30	3,50	3,60	3,70	3,90	4,00	4,20	4,40	5,10	5,70

**10812F38F**

Flessibile in Acciaio Inox AISI 304 - DN8 1/2°F - 3/8°F.
Stainless Steel Flexible hose AISI 304 - DN8 1/2°F - 3/8°F.

cm	20	25	30	35	40	45	50	60	80	100
€	3,30	3,50	3,60	3,70	3,90	4,00	4,20	4,40	5,10	5,70

**10812M38F**

Flessibile in Acciaio Inox AISI 304 - DN8 1/2°M - 3/8°F.
Stainless Steel Flexible hose AISI 304 - DN8 1/2°M - 3/8°F.

cm	20	25	30	35	40	45	50	60	80	100
€	3,30	3,50	3,60	3,70	3,90	4,00	4,20	4,40	5,10	5,70

**10838M12F**

Flessibile in Acciaio Inox AISI 304 - DN8 3/8°M - 1/2°F.
Stainless Steel Flexible hose AISI 304 - DN8 3/8°M - 1/2°F.

cm	20	25	30	35	40	45	50	60	80	100
€	3,30	3,50	3,60	3,70	3,90	4,00	4,20	4,40	5,10	5,70

**10810BTB**

Flessibile in Acciaio Inox AISI 304 - DN8 10B - TB10 mm.
Stainless Steel Flexible hose AISI 304 - DN8 10B - TB10 mm.

cm	20	25	30	35	40	45	50	60	80	100
€	4,10	4,30	4,40	4,70	4,80	5,00	5,10	5,40	6,00	6,70

**10810B12F**

Flessibile in Acciaio Inox AISI 304 - DN8 10B - 1/2°F.
Stainless Steel Flexible hose AISI 304 - DN8 10B - 1/2°F.

cm	20	25	30	35	40	45	50	60	80	100
€	3,90	4,00	4,10	4,20	4,30	4,40	4,50	4,70	5,20	5,60

**10810B38F**

Flessibile in Acciaio Inox AISI 304 - DN8 10B - 3/8°F.
Stainless Steel Flexible hose AISI 304 - DN8 10B - 3/8°F.

cm	20	25	30	35	40	45	50	60	80	100
€	3,90	4,00	4,10	4,20	4,30	4,40	4,50	4,70	5,20	5,60

**10810B12M**

Flessibile in Acciaio Inox AISI 304 - DN8 10B - 1/2°M.
Stainless Steel Flexible hose AISI 304 - DN8 10B - 1/2°M.

cm	20	25	30	35	40	45	50	60	80	100
€	3,90	4,00	4,10	4,20	4,30	4,40	4,50	4,70	5,20	5,60

**10810B38M**

Flessibile in Acciaio Inox AISI 304 - DN8 10B - 3/8°M.
Stainless Steel Flexible hose AISI 304 - DN8 10B - 3/8°M.

cm	20	25	30	35	40	45	50	60	80	100
€	3,90	4,00	4,10	4,20	4,30	4,40	4,50	4,70	5,20	5,60



FLESSIBILI DN 10 ACCIAIO INOX

FLESSIBILI PER SANITARI

STAINLESS STEEL DN 10 FLEXIBLES

FLEXIBLES FOR SANITARIES



DATI TECNICI - TECHNICAL DATA:

Tubo flessibile trecciato made in Italy in acciaio Inox AISI 304 con interno in gomma alimentare EPDM utilizzato prevalentemente per il collegamento tra la rete idrica e i rubinetti singoli, gli scaldabagni, le pareti doccia attrezzate e le vasche idromassaggio oltre che ai rubinetti posti sulle cucine industriali. Tutti i flessibili sono raccordati con macchine automatiche ed il risultato è l'assoluta precisione di ogni pezzo prodotto per una garanzia di totale qualità.

Made in Italy braided hose in AISI 304 stainless steel with internal in non-toxic EPDM rubber, mainly used for the connection between the water mains and the single faucet, the boilers, the equipped shower sets and the hydromassage tubs, besides the taps are placed on industrial kitchens. All the hoses are produced with automatic machines and the result is the absolute precision of each produced piece for a total quality guarantee.

APPLICAZIONI - APPLICATIONS



MATERIALI - MATERIALS

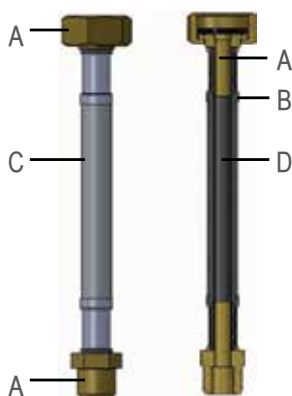

RACCORDI - FITTINGS:

- A) Ottone CW614N e CW617N nichelato
Brass CW614N and CW617N nickel plated

BUSSOLE - SLEEVES:

- B) Acciaio INOX AISI 304
Stainless steel AISI 304

TUBO - HOSE:

- C) Treccia 7-8 fili in acciaio INOX AISI 304
7-8 Wires Braid in steel INOX AISI 304
D) Tubo interno: gomma EPDM atossico
Internal pipe EPDM rubber, atoxic

CRATTERISTICHE - FEATURES



TEMPERATURA INSTALLAZIONE - INSTALLATION TEMPERATURE:

Da -5°C a +90°C - From -5°C to +90°C



PRESSIONE D'ESERCIZIO - WORKING PRESSURE:

10 BAR



PORTATA A 3 BAR - FLOW RATE AT 3 BAR:

42 lit/min



TEMPERATURA D'IMPIEGO - WORKING TEMPERATURE:

-5°C - +90°C



FORO MINIMO PASSAGGIO D'ACQUA - FITTING INNER DIAMETER:

7 mm



RAGGIO CURVATURA MINIMO - MINIMUM BENDING RADIUS:

30 mm



Ø INTERNO - INNER Ø:

Ø 10 mm



Ø ESTERNO - OUTER Ø:

Ø 14 mm

FLESSIBILI
FLEXIBLE HOSES

MINUTERIA
MINUTERY

VALVOLE
VALVES

RACCORDERIA
FITTINGS

ACCESSORI
ACCESSORIES

COMPONENTI PLASTICI
PLASTIC COMPONENTS

10012F12F



Flessibile in Acciaio Inox AISI 304 - DN10 1/2°F - 1/2°F.
Stainless Steel Flexible hose AISI 304 - DN10 1/2°F - 1/2°F.

cm	20	25	30	35	40	45	50	60	80	100
€	3,30	3,40	3,50	3,60	3,80	4,00	4,10	4,40	5,10	5,70

10038F38F



Flessibile in Acciaio Inox AISI 304 - DN10 3/8°F - 3/8°F.
Stainless Steel Flexible hose AISI 304 - DN10 3/8°F - 3/8°F.

cm	20	25	30	35	40	45	50	60	80	100
€	3,30	3,40	3,50	3,60	3,80	4,00	4,10	4,40	5,10	5,70

10012F38F



Flessibile in Acciaio Inox AISI 304 - DN10 1/2°F - 3/8°F.
Stainless Steel Flexible hose AISI 304 - DN10 1/2°F - 3/8°F.

cm	20	25	30	35	40	45	50	60	80	100
€	3,30	3,40	3,50	3,60	3,80	4,00	4,10	4,40	5,10	5,70

10012M38F



Flessibile in Acciaio Inox AISI 304 - DN10 1/2°M - 3/8°F.
Stainless Steel Flexible hose AISI 304 - DN10 1/2°M - 3/8°F.

cm	20	25	30	35	40	45	50	60	80	100
€	3,30	3,40	3,50	3,60	3,80	4,00	4,10	4,40	5,10	5,70

10012F34F



Flessibile in Acciaio Inox AISI 304 - DN10 1/2°F - 3/4°F.
Stainless Steel Flexible hose AISI 304 - DN10 1/2°F - 3/4°F.

cm	20	25	30	35	40	45	50	60	80	100
€	4,30	4,50	4,70	4,80	5,00	5,20	5,30	5,60	6,30	6,90

10034F34F



Flessibile in Acciaio Inox AISI 304 - DN10 3/4°F - 3/4°F.
Stainless Steel Flexible hose AISI 304 - DN10 3/4°F - 3/4°F.

cm	20	25	30	35	40	45	50	60	80	100
€	5,40	5,60	5,70	5,80	6,00	6,30	6,40	6,70	7,30	8,00

10012M12F



Flessibile in Acciaio Inox AISI 304 - DN10 1/2°M - 1/2°F.
Stainless Steel Flexible hose AISI 304 - DN10 1/2°M - 1/2°F.

cm	20	25	30	35	40	45	50	60	80	100
€	3,30	3,40	3,50	3,60	3,80	4,00	4,10	4,40	5,10	5,70

10038M38F



Flessibile in Acciaio Inox AISI 304 - DN10 3/8°M - 3/8°F.
Stainless Steel Flexible hose AISI 304 - DN10 3/8°M - 3/8°F.

cm	20	25	30	35	40	45	50	60	80	100
€	3,30	3,40	3,50	3,60	3,80	4,00	4,10	4,40	5,10	5,70

10038M12F



Flessibile in Acciaio Inox AISI 304 - DN10 3/8°M - 1/2°F.
Stainless Steel Flexible hose AISI 304 - DN10 3/8°M - 1/2°F.

cm	20	25	30	35	40	45	50	60	80	100
€	3,30	3,40	3,50	3,60	3,80	4,00	4,10	4,40	5,10	5,70

10034M12F



Flessibile in Acciaio Inox AISI 304 - DN10 3/4°M - 1/2°F.
Stainless Steel Flexible hose AISI 304 - DN10 3/4°M - 1/2°F.

cm	20	25	30	35	40	45	50	60	80	100
€	4,30	4,50	4,70	4,80	5,00	5,20	5,30	5,60	6,30	6,90

10012M34F



Flessibile in Acciaio Inox AISI 304 - DN10 1/2°M - 3/4°F.
Stainless Steel Flexible hose AISI 304 - DN10 1/2°M - 3/4°F.

cm	20	25	30	35	40	45	50	60	80	100
€	4,30	4,50	4,70	4,80	5,00	5,20	5,30	5,60	6,30	6,90

10034M34F



Flessibile in Acciaio Inox AISI 304 - DN10 3/4°M - 3/4°F.
Stainless Steel Flexible hose AISI 304 - DN10 3/4°M - 3/4°F.

cm	20	25	30	35	40	45	50	60	80	100
€	5,40	5,60	5,70	5,80	6,00	6,30	6,40	6,70	7,30	8,00

100C12F12F



Flessibile in Acciaio Inox AISI 304 - DN10 1/2°F - 1/2°F.
Stainless Steel Flexible hose AISI 304 - DN10 1/2°F - 1/2°F.

cm	20	25	30	35	40	45	50	60	80	100
€	5,10	5,20	5,30	5,50	5,60	5,70	5,90	6,30	6,90	7,50

100C12F34F



Flessibile in Acciaio Inox AISI 304 - DN10 1/2°F - 3/4°F.
Stainless Steel Flexible hose AISI 304 - DN10 1/2°F - 3/4°F.

cm	20	25	30	35	40	45	50	60	80	100
€	6,40	6,50	6,70	6,80	7,00	7,20	7,30	7,60	8,40	9,00

100C12M12F



Flessibile in Acciaio Inox AISI 304 - DN10 1/2°M - 1/2°F.
Stainless Steel Flexible hose AISI 304 - DN10 1/2°M - 1/2°F.

cm	20	25	30	35	40	45	50	60	80	100
€	5,10	5,20	5,30	5,50	5,60	5,70	5,90	6,30	6,90	7,50

100C12M34F



Flessibile in Acciaio Inox AISI 304 - DN10 1/2°M - 3/4°F.
Stainless Steel Flexible hose AISI 304 - DN10 1/2°M - 3/4°F.

cm	20	25	30	35	40	45	50	60	80	100
€	6,40	6,50	6,70	6,80	7,00	7,20	7,30	7,60	8,40	9,00

FLESSIBILI - FLEXIBLE HOSES

100C34F12F

Flessibile in Acciaio Inox AISI 304 - DN10 3/4"F - 1/2"FC.
Stainless Steel Flexible hose AISI 304 - DN10 3/4"F - 1/2"FC.

cm	20	25	30	35	40	45	50	60	80	100
€	6,40	6,50	6,70	6,80	7,00	7,20	7,30	7,60	8,40	9,00



100C34M12F

Flessibile in Acciaio Inox AISI 304 - DN10 3/4"M - 1/2"FC.
Stainless Steel Flexible hose AISI 304 - DN10 3/4"M - 1/2"FC.

cm	20	25	30	35	40	45	50	60	80	100
€	6,40	6,50	6,70	6,80	7,00	7,20	7,30	7,60	8,40	9,00



100C38F12F

Flessibile in Acciaio Inox AISI 304 - DN10 3/8"F - 1/2"FC.
Stainless Steel Flexible hose AISI 304 - DN10 3/8"F - 1/2"FC.

cm	20	25	30	35	40	45	50	60	80	100
€	5,00	5,10	5,30	5,40	5,60	5,70	5,90	6,30	6,90	7,50



100C38M12F

Flessibile in Acciaio Inox AISI 304 DN10 - 3/8"M - 1/2"FC.
Stainless Steel Flexible hose AISI 304 DN10 - 3/8"M - 1/2"FC.

cm	20	25	30	35	40	45	50	60	80	100
€	5,00	5,10	5,30	5,40	5,60	5,70	5,90	6,30	6,90	7,50



100C34F34F

Flessibile in Acciaio Inox AISI 304 - DN10 3/4"F - 3/4"FC.
Stainless Steel Flexible hose AISI 304 - DN10 3/4"F - 3/4"FC.

cm	20	25	30	35	40	45	50	60	80	100
€	7,50	7,60	7,80	8,00	8,10	8,30	8,50	8,70	9,50	10,10



100C34M34F

Flessibile in Acciaio Inox AISI 304 - DN10 3/4"M - 3/4"FC.
Stainless Steel Flexible hose AISI 304 - DN10 3/4"M - 3/4"FC.

cm	20	25	30	35	40	45	50	60	80	100
€	7,50	7,60	7,80	8,00	8,10	8,30	8,50	8,70	9,50	10,10



10312M12F

Flessibile in Acciaio Inox AISI 304 - DN10 1/2"ML - 1/2"F.
Stainless Steel Flexible hose AISI 304 - DN10 1/2"ML - 1/2"F.

cm	20	25	30	35	40	45	50	60	80	100
€	4,10	4,20	4,30	4,50	4,70	4,90	5,00	5,30	5,90	6,60



10338M38F

Flessibile in Acciaio Inox AISI 304 - DN10 3/8"ML - 3/8"F.
Stainless Steel Flexible hose AISI 304 - DN10 3/8"ML - 3/8"F.

cm	20	25	30	35	40	45	50	60	80	100
€	4,10	4,20	4,30	4,50	4,70	4,90	5,00	5,30	5,90	6,60



10338M12F

Flessibile in Acciaio Inox AISI 304 - DN10 3/8"ML - 1/2"F.
Stainless Steel Flexible hose AISI 304 - DN10 3/8"ML - 1/2"F.

cm	20	25	30	35	40	45	50	60	80	100
€	4,10	4,20	4,30	4,50	4,70	4,90	5,00	5,30	5,90	6,60



10312M38F

Flessibile in Acciaio Inox AISI 304 - DN10 1/2"ML - 3/8"F.
Stainless Steel Flexible hose AISI 304 - DN10 1/2"ML - 3/8"F.

cm	20	25	30	35	40	45	50	60	80	100
€	4,10	4,20	4,30	4,50	4,70	4,90	5,00	5,30	5,90	6,60



10612F

Flessibile in Acciaio Inox AISI 304 - DN10 10B - 1/2"F.
Stainless Steel Flexible hose AISI 304 - DN10 10B - 1/2"F.

cm	20	25	30	35	40	45	50	60	80	100
€	4,10	4,30	4,40	4,50	4,80	4,90	5,10	5,40	6,00	6,60



10612M

Flessibile in Acciaio Inox AISI 304 - DN10 10B - 1/2"M.
Stainless Steel Flexible hose AISI 304 - DN10 10B - 1/2"M.

cm	20	25	30	35	40	45	50	60	80	100
€	4,10	4,30	4,40	4,50	4,80	4,90	5,10	5,40	6,00	6,60



10638F

Flessibile in Acciaio Inox AISI 304 - DN10 10B - 3/8"F.
Stainless Steel Flexible hose AISI 304 - DN10 10B - 3/8"F.

cm	20	25	30	35	40	45	50	60	80	100
€	4,10	4,30	4,40	4,50	4,80	4,90	5,10	5,40	6,00	6,60



10638M

Flessibile in Acciaio Inox AISI 304 - DN10 10B - 3/8"M.
Stainless Steel Flexible hose AISI 304 - DN10 10B - 3/8"M.

cm	20	25	30	35	40	45	50	60	80	100
€	4,10	4,30	4,40	4,50	4,80	4,90	5,10	5,40	6,00	6,60



FLESSIBILI
FLEXIBLE HOSES

MINUTERIA
MINUTERY

VALVOLE
VALVES

RACCORDERIA
FITTINGS

ACCESSORI
ACCESSORIES

COMPONENTI PLASTICI
PLASTIC COMPONENTS

FLESSIBILI DN 13 ACCIAIO INOX

FLESSIBILI PER SCALDABAGNO,
CALDAIE ED ELETTRODOMESTICI

STAINLESS STEEL DN 13 FLEXIBLES

FLEXIBLES HOSES FOR WATER HEATERS,
BOILERS AND HOUSEHOLD APPLIANCES



DATI TECNICI - TECHNICAL DATA:

Tubo flessibile trecciato made in Italy in acciaio Inox AISI 304 con interno in gomma alimentare EPDM utilizzato prevalentemente per il collegamento tra la rete idrica e i rubinetti singoli, gli scaldabagni, le pareti doccia attrezzate e le vasche idromassaggio oltre che ai rubinetti posti sulle cucine industriali. Tutti i flessibili sono raccordati con macchine automatiche ed il risultato e' l'assoluta precisione di ogni pezzo prodotto per una garanzia di totale qualità.

Made in Italy braided hose in AISI 304 stainless steel with internal in non-toxic EPDM rubber, mainly used for the connection between the water mains and the single faucet, the boilers, the equipped shower sets and the hydromassage tubs, besides the taps are placed on industrial kitchens. All the hoses are produced with automatic machines and the result is the absolute precision of each produced piece for a total quality guarantee.

APPLICAZIONI - APPLICATIONS



MATERIALI - MATERIALS

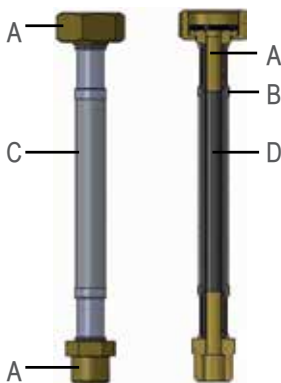

RACCORDI - FITTINGS:
A) CW617N nichelato o giallo
Brass CW617N nickel plated or yellow

BUSSOLE - SLEEVES:
B) Acciaio INOX AISI 304
Stainless steel AISI 304

TUBO - HOSE:
C) Treccia 9 fili in acciaio INOX AISI 304
9 Wires Braid in steel INOX AISI 304
D) Tubo interno: gomma EPDM atossico
Internal pipe EPDM rubber, atoxic

CRATTERISTICHE - FEATURES



TEMPERATURA INSTALLAZIONE - INSTALLATION TEMPERATURE:

Da -5°C a +90°C - From -5°C to +90°C



PRESSIONE D'ESERCIZIO - WORKING PRESSURE:

16 BAR



PORTATA A 3 BAR - FLOW RATE AT 3 BAR:

65 lit/min



TEMPERATURA D'IMPIEGO - WORKING TEMPERATURE:

-5°C - +90°C



FORO MINIMO PASSAGGIO D'ACQUA - FITTING INNER DIAMETER:

9,3 mm



RAGGIO CURVATURA MINIMO - MINIMUM BENDING RADIUS:

45 mm



Ø INTERNO - INNER Ø:

Ø 13 mm



Ø ESTERNO - OUTER Ø:

Ø 18 mm

11612F12F

Flessibile in Acciaio Inox AISI 304 - DN13 1/2"F - 1/2"F
Stainless Steel Flexible hose AISI 304 - DN13 1/2"F - 1/2"F

cm	20	25	30	35	40	45	50	60	80	100
€	4,20	4,40	4,70	5,00	5,20	5,40	5,60	6,00	7,00	7,90

11612M12F

Flessibile in Acciaio Inox AISI 304 - DN13 1/2"M - 1/2"F
Stainless Steel Flexible hose AISI 304 - DN13 1/2"M - 1/2"F

cm	20	25	30	35	40	45	50	60	80	100
€	4,20	4,40	4,70	5,00	5,20	5,40	5,60	6,00	7,00	7,90

FLESSIBILI - FLEXIBLE HOSES

FLESSIBILI
FLEXIBLE HOSES

11634F34F

Flessibile in Acciaio Inox AISI 304 - DN13 3/4" F - 3/4" F
Stainless Steel Flexible hose AISI 304 - DN13 3/4" F - 3/4" F

cm	20	25	30	35	40	45	50	60	80	100
€	6,50	6,70	6,90	7,10	7,30	7,50	7,80	8,30	9,10	10,10



11634M34F

Flessibile in Acciaio Inox AISI 304 - DN13 3/4" M - 3/4" F
Stainless Steel Flexible hose AISI 304 - DN13 3/4" M - 3/4" F

cm	20	25	30	35	40	45	50	60	80	100
€	6,50	6,70	6,90	7,10	7,30	7,50	7,80	8,30	9,10	10,10



11612F34F

Flessibile in Acciaio Inox AISI 304 - DN13 1/2" F - 3/4" F
Stainless Steel Flexible hose AISI 304 - DN13 1/2" F - 3/4" F

cm	20	25	30	35	40	45	50	60	80	100
€	5,50	5,70	5,90	6,10	6,40	6,60	6,80	7,30	8,20	9,10



11612M34F

Flessibile in Acciaio Inox AISI 304 - DN13 1/2" M - 3/4" F
Stainless Steel Flexible hose AISI 304 - DN13 1/2" M - 3/4" F

cm	20	25	30	35	40	45	50	60	80	100
€	5,50	5,70	5,90	6,10	6,40	6,60	6,80	7,30	8,20	9,10



MINUTERIA
MINUTERY

11634M12F

Flessibile in Acciaio Inox AISI 304 - DN13 3/4" M - 1/2" F
Stainless Steel Flexible hose AISI 304 - DN13 3/4" M - 1/2" F

cm	20	25	30	35	40	45	50	60	80	100
€	5,50	5,70	5,90	6,10	6,40	6,60	6,80	7,30	8,20	9,10



VALVOLE
VALVES

116C12F12F

Flessibile in Acciaio Inox AISI 304 - DN13 1/2" F - 1/2" FC
Stainless Steel Flexible hose AISI - 304 DN13 1/2" F - 1/2" FC

cm	20	25	30	35	40	45	50	60	80	100
€	7,10	7,30	7,50	7,80	8,00	8,20	8,50	8,90	9,80	10,70



116C12M12F

Flessibile in Acciaio Inox AISI 304 - DN13 1/2" M - 1/2" FC
Stainless Steel Flexible hose AISI 304 - DN13 1/2" M - 1/2" FC

cm	20	25	30	35	40	45	50	60	80	100
€	7,10	7,30	7,50	7,80	8,00	8,20	8,50	8,90	9,80	10,70



RACCORDERIA
FITTINGS

116C34F34F

Flessibile in Acciaio Inox AISI 304 - DN13 3/4" F - 3/4" FC
Stainless Steel Flexible hose AISI 304 - DN13 3/4" F - 3/4" FC

cm	20	25	30	35	40	45	50	60	80	100
€	10,00	10,20	10,40	10,60	10,90	11,10	11,30	11,80	12,70	13,60



116C34M34F

Flessibile in Acciaio Inox AISI 304 - DN13 3/4" M - 3/4" FC
Stainless Steel Flexible hose AISI 304 - DN13 3/4" M - 3/4" FC

cm	20	25	30	35	40	45	50	60	80	100
€	10,00	10,20	10,40	10,60	10,90	11,10	11,30	11,80	12,70	13,60



ACCESSORI
ACCESSORIES

116C12F34F

Flessibile in Acciaio Inox AISI 304 - DN13 1/2" F - 3/4" FC
Stainless Steel Flexible hose AISI 304 - DN13 1/2" F - 3/4" FC

cm	20	25	30	35	40	45	50	60	80	100
€	9,00	9,30	9,50	9,70	9,90	10,20	10,40	10,90	11,70	12,70



116C12M34F

Flessibile in Acciaio Inox AISI 304 - DN13 1/2" M - 3/4" FC
Stainless Steel Flexible hose AISI 304 - DN13 1/2" M - 3/4" FC

cm	20	25	30	35	40	45	50	60	80	100
€	9,00	9,30	9,50	9,70	9,90	10,20	10,40	10,90	11,70	12,70



COMPONENTI PLASTICI
PLASTIC COMPONENTS

116C34F12F

Flessibile in Acciaio Inox AISI 304 - DN13 3/4" F - 1/2" FC
Stainless Steel Flexible hose AISI 304 - DN13 3/4" F - 1/2" FC

cm	20	25	30	35	40	45	50	60	80	100
€	9,00	9,30	9,50	9,70	9,90	10,20	10,40	10,90	11,70	12,70



FLESSIBILI ANTIVIBRANTI

IN ACCIAIO ZINCATO

ANTI-VIBRATION FLEXIBLES

IN GALVANIZED STEEL



DATI TECNICI - TECHNICAL DATA:

Flessibili antivibranti made in Italy rivestiti con treccia in Acciaio Zincato ed interno in tubo in gomma alimentare EPDM utilizzati per il collegamento tra la rete idrica e pompe, caldaie, autoclavi e depuratori, sono disponibili nelle misure da 1/2" fino a 2". Tutti i flessibili sono raccordati con macchine automatiche ed il risultato è l'assoluta precisione di ogni pezzo prodotto per una garanzia di totale qualità.

Made in Italy anti-vibration flexible hoses, galvanized steel braided, with internal in non-toxic EPDM rubber, used for the connection between the water mains and pumps, boilers, autoclaves and water conditioner; available from 1/2" to 2" size. All the hoses are connected with automatic machines and the result is the absolute precision of each produced piece for a total quality guarantee.

APPLICAZIONI - APPLICATIONS



MATERIALI - MATERIALS

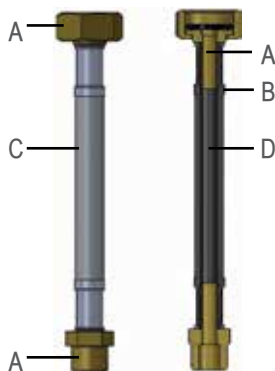

RACCORDI - FITTINGS:

A) Ottone CW614N e CW617N giallo o nichelato
Brass CW614N and CW617N yellow or nickel plated







BUSSOLE - SLEEVES:

B) Alluminio 99,5%
Aluminium 99,5%

TUBO - HOSE:

C) Treccia in Acciaio Zincato
wires braid n stainless steel galvanized
D) Tubo interno: gomma EPDM atossico
Internal pipe EPDM rubber, atoxic

CRATTERISTICHE - FEATURES

	DN 13 - 1/2"	DN 19 - 3/4"	DN 25 - 1"	DN 32 1" 1/4	DN 40 - 1" 1/2	DN 50 2"
	PRESSIONE D'ESERCIZIO - WORKING PRESSURE:					
	10 BAR	10 BAR	10 BAR	6 BAR	6 BAR	4 BAR
	PORTATA A 3 BAR - FLOW RATE AT 3 BAR:					
	120 lit/min	120 lit/min	200 lit/min	400 lit/min	700 lit/min	1.050 lit/min
	TEMPERATURA D'IMPIEGO - WORKING TEMPERATURE:					
	-10°C +90°C	-10°C +90°C	-10°C +90°C	-10°C +90°C	-10°C +90°C	-10°C +90°C
	FORO MINIMO PASSAGGIO D'ACQUA - FITTING INNER DIAMETER:					
	9,3 mm	15 mm	20 mm	26 mm	32 mm	41 mm
	RAGGIO CURVATURA MINIMO - MINIMUM BENDING RADIUS:					
	45 mm	70 mm	100 mm	190 mm	230 mm	300 mm
	Ø INTERNO - INNER Ø:					
	Ø 13 mm	Ø 19 mm	Ø 25 mm	Ø 30 mm	Ø 40 mm	Ø 50 mm
	Ø ESTERNO - OUTER Ø:					
	Ø 19 mm	Ø 27 mm	Ø 33 mm	Ø 42 mm	Ø 52 mm	Ø 62 mm

FLESSIBILI ANTIVIBRANTI INOX

TRECCIA IN ACCIAIO INOX PER POMPE E AUTOCLAVI

STAINLESS STEEL ANTI-VIBRATION FLEXIBLES

STAINLESS STEEL BRAIDED FOR PUMPS AND AUTOCLAVES



DATI TECNICI - TECHNICAL DATA:

Flessibili antivibranti made in Italy rivestiti con treccia in Acciaio Inox AISI 304 ed interno in tubo in gomma alimentare EPDM utilizzati per il collegamento tra la rete idrica e pompe, caldaie, autoclavi e depuratori, sono disponibili nelle misure da 1/2" fino a 2". Tutti i flessibili sono raccordati con macchine automatiche ed il risultato è l'assoluta precisione di ogni pezzo prodotto per una garanzia di totale qualità.

Made in Italy anti-vibration flexible hoses, AISI 304 stainless steel braided, with internal in non-toxic EPDM rubber, used for the connection between the water mains and pumps, boilers, autoclaves and water conditioner; available from 1/2" to 2" size. All the hoses are connected with automatic machines and the result is the absolute precision of each produced piece for a total quality guarantee.

APPLICAZIONI - APPLICATIONS



MATERIALI - MATERIALS

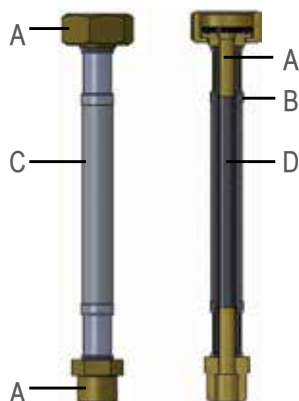

RACCORDI - FITTINGS:

A) Ottone CW614N e CW617N giallo o nichelato
Brass CW614N and CW617N yellow or nickel plated

BUSSOLE - SLEEVES:

B) Alluminio 99,5%
Aluminium 99,5%

TUBO - HOSE:

C) Treccia in Acciaio AISI 304
Braid in Steel AISI 304
D) Tubo interno: gomma EPDM atossico
Internal pipe EPDM rubber, atoxic

GRATTERISTICHE - FEATURES

	DN 13 - 1/2"	DN 19 - 3/4"	DN 25 - 1"	DN 32 1" 1/4	DN 40 - 1" 1/2	DN 50 2"
	PRESSIONE D'ESERCIZIO - WORKING PRESSURE:					
	15 BAR	15 BAR	15 BAR	9 BAR	6 BAR	7 BAR
	PORTATA A 3 BAR - FLOW RATE AT 3 BAR:					
	65 lit/min	120 lit/min	200 lit/min	400 lit/min	700 lit/min	1.050 lit/min
	TEMPERATURA D'IMPIEGO - WORKING TEMPERATURE:					
	-10°C +90°C	-10°C +90°C	-10°C +90°C	-10°C +90°C	-10°C +90°C	-10°C +90°C
	FORO MINIMO PASSAGGIO D'ACQUA - FITTING INNER DIAMETER:					
	9,3 mm	15 mm	20 mm	25 mm	32 mm	40 mm
	RAGGIO CURVATURA MINIMO - MINIMUM BENDING RADIUS:					
	45 mm	70 mm	100 mm	190 mm	230 mm	300 mm
	Ø INTERNO - INNER Ø:					
	Ø 13 mm	Ø 19 mm	Ø 25 mm	Ø 30 mm	Ø 40 mm	Ø 50 mm
	Ø ESTERNO - OUTER Ø:					
	Ø 19 mm	Ø 27 mm	Ø 33 mm	Ø 42 mm	Ø 52 mm	Ø 62 mm

FLESSIBILI - FLEXIBLE HOSES

FLESSIBILE IN ACCIAIO INOX AISI 304 E RACCORDI IN OTTONE NICHELATO



Flessibile in Acciaio INOX AISI 304 e raccordo in ottone nichelato.
Stainless Steel Flexible hose AISI 304 and nickel-plated brass fittings.

ART.	TUBO - HOSE					RACCORDI - FITTINGS				
	cm	20	30	40	50	60	70	80	90	100
44312					DN13					1/2" M - 1/2" F
€	6,30	6,90	7,50	8,20	8,80	9,50	10,10	10,70	11,40	
44334					DN19					3/4" M - 3/4" F
€	8,40	9,50	10,50	11,60	12,70	13,70	14,80	15,90	17,00	
44310					DN25					1" M - 1" F
€	11,90	13,30	14,70	16,00	17,40	18,80	20,20	21,40	22,80	

STAINLESS STEEL FLEXIBLE HOSE AISI 304 AND NICKEL-PLATED BRASS FITTINGS



Flessibile in Acciaio INOX AISI 304 e raccordo in ottone nichelato.
Stainless Steel Flexible hose AISI 304 and nickel-plated brass fittings.

ART.	TUBO - HOSE					RACCORDI - FITTINGS				
	cm	20	30	40	50	60	70	80	90	100
443FF12					DN13					1/2" F - 1/2" F
€	6,30	6,90	7,50	8,20	8,80	9,50	10,10	10,70	11,40	
443FF34					DN19					3/4" F - 3/4" F
€	8,40	9,50	10,50	11,60	12,70	13,70	14,80	15,90	17,00	
443FF10					DN25					1" F - 1" F
€	11,90	13,30	14,70	16,00	17,40	18,80	20,20	21,40	22,80	



Flessibile in Acciaio INOX AISI 304 e raccordo in ottone nichelato.
Stainless Steel Flexible hose AISI 304 and nickel-plated brass fittings.

ART.	TUBO - HOSE					RACCORDI - FITTINGS				
	cm	20	30	40	50	60	70	80	90	100
443C12					DN13					1/2" M - 1/2" FC
€	9,10	9,80	10,50	11,20	11,80	12,50	13,10	13,70	14,50	
443C34					DN19					3/4" M - 3/4" FC
€	14,00	15,00	16,10	17,30	18,30	19,50	20,60	21,80	22,80	
443C10					DN25					1" M - 1" FC
€	19,20	20,60	22,00	23,40	24,80	26,30	27,70	29,00	30,40	



Flessibile in Acciaio INOX AISI 304 e raccordo in ottone nichelato.
Stainless Steel Flexible hose AISI 304 and nickel-plated brass fittings.

ART.	TUBO - HOSE					RACCORDI - FITTINGS				
	cm	20	30	40	50	60	70	80	90	100
443FC12					DN13					1/2" F - 1/2" FC
€	9,10	9,80	10,50	11,20	11,80	12,50	13,10	13,70	14,50	
443FC34					DN19					3/4" F - 3/4" FC
€	14,00	15,00	16,10	17,30	18,30	19,50	20,60	21,80	22,80	
443FC10					DN25					1" F - 1" FC
€	19,20	20,60	22,00	23,40	24,80	26,30	27,70	29,00	30,40	

FLESSIBILE IN ACCIAIO INOX AISI 304 E RACCORDI IN OTTONE GIALLO



Flessibile in Acciaio INOX AISI 304 e raccordo in ottone giallo.
Stainless Steel Flexible hose AISI 304 and yellow brass fittings.

ART.	TUBO - HOSE					RACCORDI - FITTINGS				
	cm	20	30	40	50	60	70	80	90	100
44412					DN13					1/2" M - 1/2" F
€	6,30	6,90	7,50	8,20	8,80	9,50	10,10	10,70	11,40	
44434					DN19					3/4" M - 3/4" F
€	8,30	9,40	10,40	11,50	12,60	13,60	14,70	15,80	16,80	
44410					DN25					1" M - 1" F
€	11,80	13,10	14,50	15,90	17,20	18,60	20,00	21,30	22,60	

STAINLESS STEEL FLEXIBLE HOSE AISI 304 AND YELLOW BRASS FITTINGS



Flessibile in Acciaio INOX AISI 304 e raccordo in ottone giallo.
Stainless Steel Flexible hose AISI 304 and yellow brass fittings.

ART.	TUBO - HOSE					RACCORDI - FITTINGS				
	cm	20	30	40	50	60	70	80	90	100
444FF12					DN13					1/2" F - 1/2" F
€	6,30	6,90	7,50	8,20	8,80	9,50	10,10	10,70	11,40	
444FF34					DN19					3/4" F - 3/4" F
€	8,30	9,40	10,40	11,50	12,60	13,60	14,70	15,80	16,80	
444FF10					DN25					1" F - 1" F
€	11,80	13,10	14,50	15,90	17,20	18,60	20,00	21,30	22,60	



Flessibile in Acciaio INOX AISI 304 e raccordo in ottone giallo.
Stainless Steel Flexible hose AISI 304 and yellow brass fittings.

ART.	TUBO - HOSE					RACCORDI - FITTINGS				
	cm	20	30	40	50	60	70	80	90	100
444C12					DN13					1/2" M - 1/2" FC
€	9,10	9,90	10,50	11,20	11,80	12,50	13,10	13,90	14,50	
444C34					DN19					3/4" M - 3/4" FC
€	13,90	14,90	16,00	17,20	18,20	19,40	20,50	21,70	22,70	
444C10					DN25					1" M - 1" FC
€	19,00	20,40	21,80	23,30	24,70	26,10	27,40	28,80	30,30	



Flessibile in Acciaio INOX AISI 304 e raccordo in ottone giallo.
Stainless Steel Flexible hose AISI 304 and yellow brass fittings.

ART.	TUBO - HOSE					RACCORDI - FITTINGS				
	cm	20	30	40	50	60	70	80	90	100
444FC12					DN13					1/2" F - 1/2" FC
€	9,10	9,90	10,50	11,20	11,80	12,50	13,10	13,90	14,50	
444FC34					DN19					3/4" F - 3/4" FC
€	13,90	14,90	16,00	17,20	18,20	19,40	20,50	21,70	22,70	
444FC10					DN25					1" F - 1" FC
€	19,00	20,40	21,80	23,30	24,70	26,10	27,40	28,80	30,30	

FLESSIBILI
FLEXIBLE HOSES

MINUTERIA
MINUTERY

VALVOLE
VALVES

RACCORDERIA
FITTINGS

ACCESSORI
ACCESSORIES

COMPONENTI PLASTICI
PLASTIC COMPONENTS

TUBI DI RAME - COPPER TUBES



11110R0T5 € 55,00
 Tubo in rame ricotto cromato in barre da 5 metri Ø10 mm.
 Pipe in soft copper chrome plated in roll of 5 meters, Ø10 mm.



11112R0T5 € 67,10
 Tubo in rame ricotto cromato in barre da 5 metri Ø12 mm.
 Pipe in soft copper chrome plated in roll of 5 meters, Ø12 mm.



11114R0T5 € 73,20
 Tubo in rame ricotto cromato in barre da 5 metri Ø14 mm.
 Pipe in soft copper chrome plated in roll of 5 meters, Ø14 mm.



11110I00 € 10,00
 Tubo in rame ricotto cromato in barre da 1 metro Ø10 mm.
 Pipe in soft copper chrome plated in roll of 1 meter, Ø10 mm.



11110I50 € 14,00
 Tubo in rame ricotto cromato in barre da 1,5 metro Ø10 mm.
 Pipe in soft copper chrome plated in roll of 1,5 meter, Ø10 mm.



114
 Tubo liscio in rame cromato Ø10 mm con cartella e dado.
 C.p. copper pipe Ø10 mm with nut.

1/2 L. cm	30	35	40	50
	€ 4,50	€ 5,10	€ 5,90	€ 6,70
3/8 L. cm	30	35	40	50
	€ 4,50	€ 5,10	€ 5,90	€ 6,70



114FF
 Tubo liscio in rame cromato Ø10 mm con 2 cartelle e 2 dadi da 1/2.
 C.p. copper pipe Ø10 mm with 2 nuts 1/2.

L. cm	30	40	50	60
	€ 5,90	€ 6,90	€ 7,80	€ 8,70



114M10
 Tubo liscio in rame cromato Ø10 mm con attacco filettato 10M x 1.
 C.p. copper pipe Ø10 mm threaded 10M x 1.

L. cm	15	35	45	50	60
	€ 2,80	€ 3,60	€ 4,40	€ 5,80	€ 6,60



114F10 € 5,30
 Tubo liscio in rame cromato Ø10 mm con attacco dado e bicono Ø10 mm. cm 35.
 C.p. copper pipe Ø10 mm with nut and 3 pcs washers Ø10 mm. cm 35.

ADATTATORI PER FLESSIBILI - FLEXIBLE HOSES ADAPTER



Adattatore per flessibili e miscelatori, attacco femmina filetto F10x1, in ottone cromato.
 Flexible hoses and mixers adapter, female connection F10x1, in chrome-plated brass.

Art.	Attacco Maschio Male Connection	Attacco Femmina Female Connection	Prezzo
108RDM8	M 8 x1	F 10x1	€ 3,60
108RDM9	M 9 x1	F 10x1	€ 3,60
108RDM11	M 11x1	F 10x1	€ 3,60
108RDM12	M 12 x1	F 10x1	€ 3,60

RACCORDI E NIPPLES - CONNECTIONS AND NIPPLES



1253810 € 2,40

1251210 € 2,50

Nipples con guarnizione in gomma, ranella ed anello tagliato in ottone. 1/2 x 10 oppure 3/8x10.
Nipples with nut and 3 pcs washers. 1/2 x 10 or 3/8x10.



125L1238 € 3,10

125L1210 € 3,90

Nipples prolungato con guarnizione in gomma, ranella ed anello tagliato in ottone. 1/2 x 3/8 oppure 1/2 x 10.
Extended c.p. nipples with nut and 3 pcs washers. 1/2 x 3/8 or 1/2 x 10.



125D € 2,90

Doppio nipple con guarnizioni in 3 pezzi. 3/8 x 10 x 10.
C.p. double nipple with nut and 3 pcs washers. 3/8 x 10 x 10.



125F3810 € 2,80

125F € 2,40

Raccordo femmina completo con guarnizioni in 3 pezzi, 1/2 x 10 oppure 3/8x10.
C.p. female connection with nut and 3 pcs washers, 1/2 x 10 or 3/8x10.



126M1210 € 5,30

Raccordo a gomito con guarnizione in gomma, ranella e anello tagliato in ottone. 1/2 x 10 mm.
Connecting elbow with nut and 3 pcs washers. 1/2 x 10 mm.



126I010 € 5,60

Raccordo a gomito con guarnizioni in gomma, ranelle e anelli tagliati in ottone. 10 x 10 mm.
Connecting elbow with 2 nuts and 3 pcs washers. 10 x 10 mm.



126T1010 € 6,40

Raccordo a T con guarnizioni in gomma, ranelle e anelli tagliati in ottone. 10 x 10 x 10 mm.
Equal T connection with 3 nuts and 3 pcs washers. 10 x 10 x 10 mm.

FLESSIBILI
FLEXIBLE HOSES

MINUTERIA
MINUTERY

VALVOLE
VALVES

RACCORDERIA
FITTINGS

ACCESSORI
ACCESSORIES

COMPONENTI PLASTICI
PLASTIC COMPONENTS

RR[®]
REMER RUBINETTERIE

MINUTERIA MINUTERY



MINUTERIA - MINUTERY

FLESSIBILI
FLEXIBLE HOSES

MINUTERIA
MINUTERY

VALVOLE
VALVES

RACCORDERIA
FITTINGS

ACCESSORI
ACCESSORIES

COMPONENTI PLASTICI
PLASTIC COMPONENTS

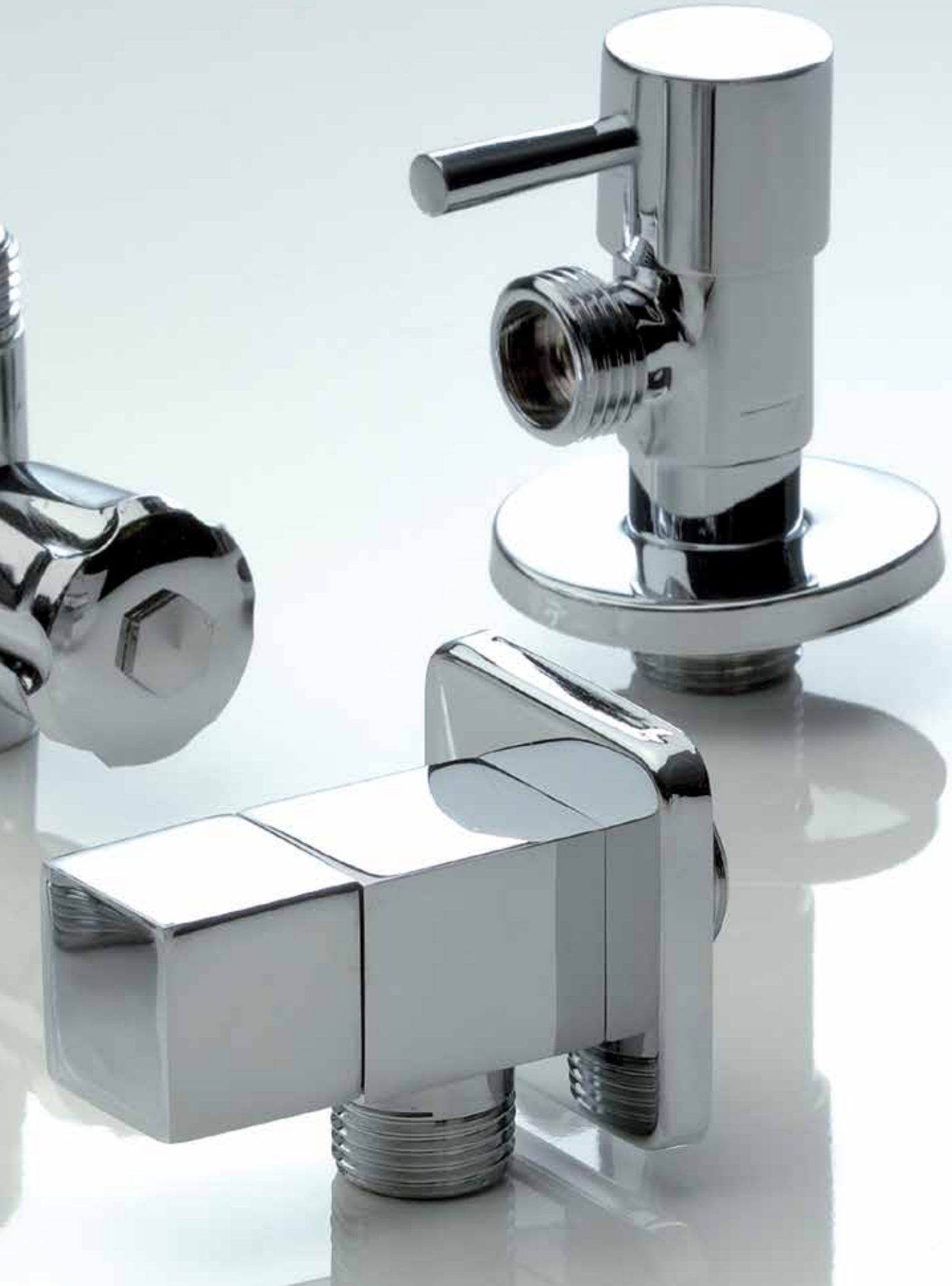

RUBINETTI SOTTOLAVABO - C.P. BRASS ANGLE VALVE



117RA € 0,95
Raccordo 3/8x10 con guarnizioni in 3 pezzi.
C.P. nut with 3 pcs washers 3/8x10.



117RA1210 € 3,35
Raccordo 1/2x10 con guarnizioni in 3 pezzi.
C.P. nut with 3 pcs washers 1/2x10.



1171238 € 5,20
Rubinetto sottolavabo con rosetta, 1/2x3/8.
C.P. brass angle valve with flange, 1/2x3/8.



1171210 € 6,00
Rubinetto sottolavabo con calotta e rosetta, 1/2x10.
C.P. brass angle valve with flange, 1/2x10.



1221210 € 8,50
Squadretta sottolavabo con snodo, attacco universale:
1/2, Ø 10 mm, con rosetta in ottone cromato.
C.P. brass angle with ball-joint and flange, 1/2x10.



1241210 € 7,40
Curvetta sottolavabo, 1/2x10, con rosetta in ottone cromato.
C.P. brass elbow connection for wash basin, with flange, 1/2x10.



124S1210 € 8,90
Curvetta sottolavabo stampata, 1/2x10, con rosetta in ottone cromato.
C.P. brass forged elbow connection for wash basin, with flange, 1/2x10.

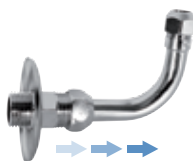

124R1210 € 7,60
Curvetta sottolavabo stampata, 1/2x10, allungabile, con rosetta in ottone cromato.
C.P. brass forged elbow connection for wash basin, extendible, with flange, 1/2x10.



120SN1210 € 11,40
Rubinetto sottolavabo a vitone, con filtro e snodo, 1/2x10, con rosetta in ottone cromato.
C.P. brass angle valve with filter, balljoint and c.p. brass flange, 1/2x10.



121T € 16,00
Rubinetto combinato 1/2" sottolavabo e 3/4" attacco lavatrice, 1/2 x 3/4 x 10.
C.P. brass union valve 1/2", with undersink coupling and 3/4" connection for washing machine, 1/2 x 3/4 x 10



118 Ø 12 € 10,20
11814 Ø 14 € 10,50
Squadretta sottolavabo Ø mm 12 e 14 x cm 15x25, con nipples e dado 1/2.
C.P. brass square angle connection Ø mm 12 and 14 x cm 15x25, with nipples and nut 1/2.



1231210 € 9,80
Rubinetto sottolavabo con filtro e calotta, 1/2x10, con rosetta in ottone cromato.
C.P. brass angle valve with filter and flange, 1/2x10.



1231212 € 9,00
Rubinetto sottolavabo con filtro, 1/2x1/2, con rosetta in ottone cromato.
C.P. brass angle valve with filter and flange, 1/2x1/2.

1231234 € 9,40
Rubinetto sottolavabo con filtro, 1/2x3/4, con rosetta in ottone cromato.
C.P. brass angle valve with filter and flange, 1/2x3/4.

1231238 € 8,80
Rubinetto sottolavabo con filtro, 1/2x3/8, con rosetta in ottone cromato.
C.P. brass angle valve with filter and flange, 1/2x3/8.



123SN1210 € 11,50
 Rubinetto sottolavabo con filtro e snodo, 1/2x10, con rosetta in ottone cromato.
 C.P. brass angle valve with filter, ball joint and flange, 1/2x10.



127ASN1210 € 8,00
 Rubinetto sottolavabo con filtro e snodo, 1/2x10, con rosetta in ottone cromato.
 C.P. brass angle valve with filter, ball joint and flange, 1/2x10.



127A1210 € 6,30
 Rubinetto sottolavabo con filtro, calotta, 1/2x10 e rosetta in ottone cromato.
 C.P. brass angle valve with filter and flange, 1/2x10.



128R1210 € 6,30
 Rubinetto a sfera con guarnizione in PTFE, con calotta e rosetta in ottone cromato, 1/2x10.
 C.P. brass ball valve with PTFE washer and flange, 1/2x10.



127A1212 1/2" x 1/2" € 5,50
127A1238 1/2" x 3/8" € 5,40

Rubinetto sottolavabo con filtro, 1/2x1/2, 1/2x3/8, con rosetta in ottone cromato.
 C.P. brass angle valve with filter and flange, 1/2x1/2, 1/2x3/8.



128R1212 1/2" x 1/2" € 5,40
128R1238 1/2" x 3/8" € 5,40

Rubinetto a sfera con guarnizione in PTFE e rosetta, 1/2x1/2 oppure 1/2x3/8.
 C.P. brass ball valve with PTFE washer and flange, 1/2x1/2 or 1/2x3/8.



1291212 € 7,30
 Rubinetto sottolavabo 1/2x1/2 con rosetta.
 C.P. brass angle valve for wash basin 1/2x1/2 with flange.

1291238 € 6,80
 Rubinetto sottolavabo 1/2x3/8 con rosetta.
 C.P. brass angle valve for wash basin 1/2x3/8 with flange.

1291210 € 7,80
 Rubinetto sottolavabo 1/2x10 con rosetta.
 C.P. brass angle valve for wash basin 1/2x10 with flange.

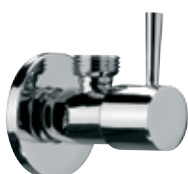

128L1238 € 14,00
 Rubinetto sottolavabo "MINIMAL", con vitone ceramico, con maniglia a leva, 1/2x3/8.
 C.P. brass "MINIMAL" angle valve, with ceramic head valve, with lever handle, 1/2x3/8.



128S1238 € 21,30
 Rubinetto sottolavabo quadrato, con vitone ceramico, 1/2x3/8.
 C.P. brass squared angle valve, with ceramic head valve, 1/2x3/8.

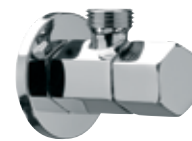

128E1238 € 18,90
 Rubinetto sottolavabo "Esagonale", con vitone ceramico, 1/2x3/8.
 C.P. brass "Hexagonal" angle valve, with ceramic head valve, 1/2x3/8.

128L1210 € 14,80
 Rubinetto sottolavabo "MINIMAL", con vitone ceramico, con maniglia a leva, dado e guarnizione art. 117 RA, 1/2x10.
 C.P. brass "MINIMAL" angle valve, with ceramic head valve, with lever handle, nut and washers art. 117 RA, 1/2x10.

128S1210 € 22,20
 Rubinetto sottolavabo quadrato, con dado e guarnizione art. 117 RA, con vitone ceramico, 1/2x10.
 C.P. brass squared angle valve, with nut and washers art. 117 RA, with ceramic head valve, 1/2x10.

128E1210 € 19,70
 Rubinetto sottolavabo "Esagonale", con dado e guarnizione art. 117 RA, con vitone ceramico, 1/2x10.
 C.P. brass "Hexagonal" angle valve, with nut and washers art. 117 RA, with ceramic head valve, 1/2x10.

128L1212 € 14,30
 Rubinetto sottolavabo "MINIMAL", con vitone ceramico, con maniglia a leva, 1/2x1/2.
 C.P. brass "MINIMAL" angle valve, with ceramic head valve, with lever handle, 1/2x1/2.

128S1212 € 21,70
 Rubinetto sottolavabo quadrato, con vitone ceramico, 1/2x1/2.
 C.P. brass squared angle valve, with ceramic head valve, 1/2x1/2.

128E1212 € 19,20
 Rubinetto sottolavabo "Esagonale", con vitone ceramico, 1/2x1/2.
 C.P. brass "Hexagonal" angle valve, with ceramic head valve, 1/2x1/2.

FLESSIBILI
FLEXIBLE HOSES

MINUTERIA
MINUTERY

VALVOLE
VALVES

RACCORDERIA
FITTINGS

ACCESSORI
ACCESSORIES

COMPONENTI PLASTICI
PLASTIC COMPONENTS

ROSETTE - WALL FLANGES



1300C12 € 0,58

Rosetta pesante in ottone cromato, 1/2.
Heavy wall flange in chrome plated brass 1/2.

130AC12 € 0,20

Rosetta pesante in acciaio inox, 1/2.
Heavy wall flange in stainless steel, 1/2.

1300C1280 1/2x80 € 3,35

Rosetta pesante in acciaio inox, Ø esterno 80 mm, 1/2. 1/2x80.
Heavy wall flange in stainless steel, external Ø 80 mm, 1/2. 1/2x80.



132

Rosetta apribile in ottone cromato.
Openable wall flange in c.p. brass.
Ø 10, 12, 14, 3/8, 1/2, 3/4, 1".

10 € 1,30 12 € 1,30 3/8 € 1,30

1/2 € 1,30 3/4 € 1,60 1" € 1,75



14212

Tappo con rosone e vite, 1/2.
Plug with wall flange and screw, 1/2.

€ 2,25



14526

€ 1,15

14530

€ 1,15

14532

€ 1,15

Rosone a muro in ottone cromato, Ø foro mm 26, 30, 32.
Standard wall flange in c.p. brass, Ø hole mm 26, 30, 32.



130N12

€ 0,98

Rosetta pesante in ottone cromato, per serie minimali, 1/2.
Heavy wall flange in chrome plated brass, for minimal series, 1/2.



1310C12

€ 1,05

Rosetta con alette pesante in ottone cromato Ø mm 57, 1/2.
Heavy wall flange in chrome plated brass Ø 57 mm, 1/2.



13612

€ 0,21

Rosetta con foro esagonale in acciaio inox, 1/2.
Stainless steel wall flange with hexagonal hole, 1/2.



14432

€ 4,50

Rosone a muro con OR, in ottone cromato, per serie minimali, Ø 32.
Wall flange without OR in c.p. brass, for minimal series, Ø 32.



14626

€ 1,70

14630

€ 1,70

14632

€ 1,70

14640

€ 1,70

Rosone a muro in ottone cromato, Ø est mm.77, Ø foro mm 26, 30, 32, 40.
Wall flange for traps in c.p. brass, ext. Ø 77 mm, hole Ø mm 26, 30, 32, 40.



130S12

€ 1,85

Rosetta pesante quadrata in ottone cromato, 1/2".
Heavy squared wall flange in c.p. brass, 1/2".



131AC12

€ 0,29

131AC34

€ 0,34

Rosetta con alette pesante in acciaio INOX Ø mm 57, 1/2 e 2/4.
Heavy wall flange in stainless steel Ø 57 mm, 1/2 and 3/4.



138

€ 9,00

Cappuccio a 2 pezzi universale, per rubinetti incasso, cromato, in ottone.
Universal cap in 2 pieces, for built-in taps, chrome plated, in brass.



144S32

€ 8,90

Rosone a muro quadrato con OR, in ottone cromato, per serie quadrate e sifoni, Ø 32.
Wall flange with OR, in c.p. brass, for squared series and traps, Ø 32.



14726

€ 5,90

14730

€ 5,90

14732

€ 5,90

Rosone a muro gigante in ottone cromato, Ø esterno mm 105, Ø foro mm 26, 30, 32.
Giant wall flange in c.p. brass, external Ø mm 105, hole Ø mm 26, 30, 32.



1400C

€ 1,60

Rosone Ø mm 77, foro ovale, in ottone cromato.
C.p. brass flange Ø mm 77, with oval hole.



141

€ 6,50

Rosone Ø mm 110, foro ovale, altezza mm 30, in ottone cromato.
C.p. brass flange Ø mm 110, height mm 30, with oval hole.



14932

€ 2,60

Dado in ottone cromato, 1" con foro Ø mm 26, 1 1/4 Ø 32, 1 1/2 Ø 40.
C.P. round nut, 1" hole Ø 26, 1 1/4 hole Ø 32, 1 1/2 hole Ø 40.

CANOTTI, RACCORDI E TUBI - TUBES AND CONNECTORS



Canotto in ottone cromato Ø 26, 30, 32, 40 lunghezza cm 30, 100.
C.P. brass tube, plain end, Ø 26, 30, 32, 40 length 30, 100 cm.

1502630	Ø26x30	€ 5,60	1503030	Ø30x30	€ 6,50
1503230	Ø32x30	€ 7,20	15032100	Ø32x100	€ 21,20
1504030	Ø40x30	€ 9,00			



Canotto pesante in ottone cromato con spessore 0,6 mm, Ø 32, lunghezza cm 30.
C.P. heavy brass tube, thickness mm 0,6, plain end, Ø 32, length cm 30.

150P3230	Ø32x30	€ 8,60
----------	--------	--------



Canotto in ottone cromato con cartella Ø 26, 30, 32 lunghezza cm 30 e Ø 32 lunghezza cm 15, 20, 25.
C.P. brass tube with bordered end Ø 26, 30, 32, length 30 cm and Ø 32 length cm 15, 20, 25.

1522630	Ø26x30	€ 6,00	1523030	Ø30x30	€ 6,90
1523215	Ø32x15	€ 4,50	1523225	Ø32x25	€ 6,10
1523220	Ø32x20	€ 5,30	1523230	Ø32x30	€ 7,60



Canotto pesante in ottone cromato con spessore 0,6 mm, con cartella, Ø 32, lunghezza cm 30.
C.P. heavy brass tube, thickness mm 0,6, with bordered end, Ø 32, length cm 30.

152P3230	Ø32x30	€ 9,00
----------	--------	--------



Canotto telescopico con guarnizione OR, Ø 26, 30, 32 lunghezza cm 13.
Telescopic tube with OR washer, Ø 26, 30, 32 length 13 cm.

15326	Ø26x13	€ 6,10
15330	Ø30x13	€ 6,40
15332	Ø32x13	€ 7,80



Raccordo di congiunzione universale, in ottone cromato, Ø 26, 30, 32, 40, con 2 guarnizioni OR.
C.P. brass universal connector, Ø mm 26, 30, 32, 40 with 2 OR washers.

15426	Ø26	€ 3,60
15430	Ø30	€ 4,30
15432	Ø32	€ 4,30
15440	Ø40	€ 5,50



Raccordo di congiunzione universale ridotto, in ottone cromato, Ø 26x32, 32x40, con 2 guarnizioni OR.
C.P. brass universal reduced connector, Ø mm 26x32, 32x40, with 2 OR washers.

154R2632	Ø26x32	€ 4,50
154R3240	Ø32x40	€ 5,50



Canotto flessibile in rame cromato, Ø 26, 30, 32, lunghezza cm 30.
Flexible tube in chrome plated copper, Ø 26, 30, 32, length 30 cm.

1552630	Ø26x30	€ 8,10
1553030	Ø30x30	€ 9,70
1553230	Ø32x30	€ 10,40



Canotto eccentrico in ottone cromato, Ø 30, lunghezza cm 30.
Eccentric C.P. brass tube, Ø 30, length 30 cm.

1583030	Ø30x30	€ 9,70
---------	--------	--------



165 € 8,90
Tubo a 90° per scarico cassetta in ottone cromato Ø cm 30, cm 15x25.
90° Tube for water tank for W.C. in C.P. brass Ø 30 cm, 15x25 cm.



166 € 7,10
Tubo a 45° per scarico cassetta in ottone cromato Ø cm 30.
45° Tube for water tank for W.C. in C.P. brass Ø 30 cm.



168 € 15,00
Canotto con dado e cartella in ottone cromato con attacco per scarico lavatrice/lavastoviglie, 1"1/4.
C.P. brass pipe with nut and bordered end, plus side connection for washing machine or dishwasher outlet tube, 1"1/4.



Tubo a "L" per flussometro esterno, in ottone cromato, Ø 25, 30.
"L" c.p. brass pipe, for wall mounted tap for wc, Ø 25, 30.

170TU25	Ø 25	€ 33,50
170TU30	Ø 30	€ 38,10

FLESSIBILI
FLEXIBLE HOSES

MINUTERIA
MINUTERY

VALVOLE
VALVES

RACCORDERIA
FITTINGS

ACCESSORI
ACCESSORIES

COMPONENTI PLASTICI
PLASTIC COMPONENTS

PASSO RAPIDO - FLUSHING VALVES



Passo rapido esterno, 3/4, 1".
External flushing valve, 3/4, 1".

17034	3/4	€ 50,00
17010	1"	€ 54,50



Vitone per passo rapido completo di leva, filetto 19/16
Headvalve for flushing valves, complete with c.p. lever, thread 19/16.

17226	Ø 26	€ 34,60
17227	Ø 27	€ 34,60
17228	Ø 28	€ 34,60
17229	Ø 29	€ 34,60



172UNI € 48,30

Vitone universale completo di maniglia per passo rapido, che permette di ottenere 12 combinazioni di misure e lunghezze. Confezione skin-pack. Universal headvalve for flushing valves, in set with lever, permit to create 12 combinations or lengths and measures. Packed in a safe skinpack.



Passo rapido a incasso con ritorno automatico, 3/4, 1".
Built-in flushing valve, with automatic return, 3/4, 1".

171RA34	3/4	€ 86,10
171RA10	1"	€ 89,90



Passo rapido a incasso con sfiataio, 3/4, 1".
Built-in flushing valve, 3/4, 1".

17134	3/4	€ 51,80
17110	1"	€ 56,80

GALLEGGIANTI - FLUSHING VALVES



Galleggiante "RR" silenzioso, 3/8, 1/2.
"RR" noiseless float valve, 3/8, 1/2.

17638	3/8	€ 7,20
17612	1/2	€ 7,80



Galleggiante tipo inglese, con tubetto, per forti erogazioni, 1/2, 3/4, 1".
Float valve, english type, with brass pipe, for high pressure, 1/2, 3/4, 1".

17512	1/2	€ 12,60
17534	3/4	€ 13,50
17510	1"	€ 17,90



174AS38 € 10,30

Galleggiante in barra con asta sagomata regolabile, 3/8.
Float valve with adjustable shaped arm, 3/8.



Galleggiante con asta in ottone regolabile, 3/4, 1", 1"1/4, 1"1/2, 2".
Float valve with adjustable brass rod, 3/4, 1", 1"1/4, 1"1/2, 2".

17834	3/4	€ 15,60
17810	1"	€ 23,70
178114	1" 1/4	€ 58,60
178112	1" 1/2	€ 75,90
17820	2"	€ 99,30



17912 € 15,40

Galleggiante silenzioso con attacco basso, 1/2.
Float valve noiseless type, bottom inlet, 1/2.



180 € 0,75
Sfera Ø 90 in plastica soffiata con noddolino in ottone.
Plastic ball Ø 90 blown for art. 176 and 179 with brass nut.



182UNI120 € 2,70
Sfera Ø 120 in plastica attacco universale: scorrevole, filetto 1/4, filetto 5/16.
Plastic ball Ø 120, universal type (1/4, 5/16, sliding) for art. 175 and 178.



Sfera in plastica con scorrevole, Ø 150, 180, 220.
Plastic ball, sliding, Ø 150, 180, 220.
182150 Ø 150 € 3,70
182180 Ø 180 € 4,40
182220 Ø 220 € 9,00



Sfera in rame tonda, Ø 85, 120, 150, 180, 220, senza noddolino.
Copper ball for float valves, Ø 85, 120 150, 180, 220, without brass nut.

18585	Ø 85	€ 9,30
185120	Ø 120	€ 18,80
185150	Ø 150	€ 22,50
185180	Ø 180	€ 30,30
185220	Ø 220	€ 47,30

RUBINETTI - TAPS



18812 € 10,30
 Rubinetto per cassetta cromato, con tubetto e rosone, 1/2.
 C.P. tap for W.C. tank with copper pipe and flange, 1/2.



Rubinetto per cassetta cromato, con tubetti e rosetta, 3/8MX3/8F, 1/2MX3/8F.
 Chrome plated W.C. tank tap, with extension pipes and flange, 3/8MX3/8F, 1/2MX3/8F.

19038 3/8MX3/8F € 14,30

19012 1/2MX3/8F € 14,30



19712 € 8,40
 Rubinetto portagomma a sfera, maniglia a leva, pulito e cromato, 1/2".
 C.P. brass polished ball bibcock, hose-end with lever handle, 1/2.



19912 € 7,30
 Rubinetto portagomma a sfera, maniglia a farfalla, cromato, 1/2.
 Brass ball bibcock, hose-end with T handle in nickel plated brass, 1/2.



Rubinetto portagomma a sfera, maniglia a leva, cromato, 3/8, 1/2, 3/4, 1".
 Brass ball bibcock, hose-end with lever handle in nickel plated brass, 3/8, 1/2, 3/4, 1".

19838 3/8 € 7,80

19812 1/2 € 7,20

19834 3/4 € 10,20

19810 1" € 19,20



Rubinetto portagomma in ottone giallo, pesante, 1/2, 3/4.
 Hose union bibcock in yellow brass, heavy duty, 1/2, 3/4.

20012 1/2 € 10,40

20034 3/4 € 14,60



Rubinetto portagomma cromato, 1/2, 3/4.
 C.p. hose union bibcock, 1/2, 3/4.

200T12 1/2 € 9,90

200T34 3/4 € 14,60



20112 € 11,40

Rubinetto curvo in ottone giallo pesante, 1/2.
 Plain-end bibcock in yellow brass, heavy duty, 1/2.



202MA € 31,90

Rubinetto curvo da giardino in ottone giallo trattato, 1/2 a maniglia, con rosetta pesante, aeratore e riduzione 3/4 per portagomma.
 Plain-end garden bibcock, heavy duty, in treated yellow brass, 1/2, traditional handle, with heavy flange, aerator and 3/4 reduction for hose connection.



202LE € 31,50

Rubinetto curvo da giardino in ottone giallo trattato, 1/2 a leva, con rosetta pesante, aeratore e riduzione 3/4 per portagomma.
 Plain-end garden bibcock, heavy duty, in treated yellow brass, 1/2, lever type, with heavy flange, aerator and 3/4 reduction for hose connection.

FLESSIBILI
FLEXIBLE HOSES

MINUTERIA
MINUTERY

VALVOLE
VALVES

RACCORDERIA
FITTINGS

ACCESSORI
ACCESSORIES

COMPONENTI PLASTICI
PLASTIC COMPONENTS



202MAVI € 4,80
 Vitone di ricambio per articolo 202MA.
 Spare part headvalve for art 202MA.



Lancia per giardinaggio in ottone con portagomma per tubi Ø interno mm 15, misura Ø15x3/4 o mm 19, misura Ø19x3/4.
 Gardening nozzle in yellow brass, with hose connection for pipes with internal Ø mm 15, size Ø 15x3/4 or Ø 19, size Ø 19x3/4.

2041534	15x3/4	€ 6,90
2041934	19x3/4	€ 7,10



Rubinetto a sfera per botte in ottone cromato Ø mm 8, 10, 12, 14, 16, 18, 20.
 Ball bibcock in c.p. brass for wine cask, with padlock ring, Ø mm 8, 10, 12, 14, 16, 18, 20.

2058	Ø 8	€ 22,00
20510	Ø 10	€ 19,10
20512	Ø 12	€ 19,10
20514	Ø 14	€ 21,90
20516	Ø 16	€ 22,80
20518	Ø 18	€ 25,60
20520	Ø 20	€ 26,50



Bocchello per art. 205 (misura del rubinetto) Ø mm 8, 10, 12, 14, 16, 18, 20.
 Nozzle end for art. 205, accordingly to size of the tap, Ø mm 8, 10, 12, 14, 16, 18, 20.

2068	Ø 8	€ 3,25
20610	Ø 10	€ 1,30
20612	Ø 12	€ 1,30
20614	Ø 14	€ 1,85
20616	Ø 16	€ 1,85
20618	Ø 18	€ 2,05
20620	Ø 20	€ 2,05



Raccordo portagomma in ottone giallo, per art. 200, 1/2, 3/4, 1" (misura del rubinetto).
 Hose connection for taps in yellow brass, for art. 200, 1/2, 3/4, 1".

20912	1/2	€ 1,20
20934	3/4	€ 2,25



Raccordo portagomma in ottone cromato, per art. 198, 1/2, 3/4, 1" (misura del rubinetto).
 C.P. hose connection for art. 198, (size of reference tap), 1/2, 3/4, 1".

21012	1/2	€ 1,60
21034	3/4	€ 2,70
21010	1"	€ 4,70



209Y € 6,40
 Raccordo a Y in ottone giallo, 3/4Fx3/4Mx3/4M.
 Y yellow brass connection, 3/4Fx3/4Mx3/4M.



209YCR € 6,80
 Raccordo a Y in ottone cromato, 3/4Fx3/4Mx3/4M.
 Y chrome brass connection, 3/4Fx3/4Mx3/4M.



57EX € 21,60
 Rubinetto curvo con maniglia mini Y, 1/2.
 C.P. polished brass bibcock, with mini Y handle, 1/2.



22412 € 29,80
 Rubinetto a snodo con maniglia mini Y, 1/2.
 C.P. brass sink tap, with swivel spout, with mini Y handle, 1/2.



25012 € 30,50
 Rubinetto a due maniglie per attacco lavatrice, 1/2x3/4.
 C.P. brass washing machine bibcock, heavy model, 1/2x3/4.



2501234 € 30,50
 Rubinetto a due maniglie per attacco lavatrice, 1/2x3/4x3/4.
 C.P. brass washing machine bibcock, heavy model, 1/2x3/4x3/4.



25212 € 37,00
 Rubinetto a snodo con attacco lavatrice, con maniglia mini Y, 1/2. C.P. brass washing machine bibcock, with swivel spout, with mini Y handle, 1/2.



255 € 17,40
 Retrogruppo completo di rubinetto a squadra, 3/4x3/4. C.P. washing machine bibcock, with connection, 3/4x3/4



256 € 8,30
 Distanziatore per gruppi in ottone cromato, 3/4x3/4, con filtro incorporato. C.P. brass connection, 3/4x3/4, with incorporated filter.



257 € 10,20
 Coppia distanziatori con foro 3/8 e senza, in ottone cromato 3/4x3/4. Set two pieces 3/4 c.p. brass connections with hole and without hole for 3/8 washing machine bibcock.



257RA38 € 5,30
 Distanziatore con foro da 3/8", in ottone cromato, 3/4 x 3/4. C.p. brass connections with 3/8" hole, 3/4 x 3/4.



258 € 16,60
 Distanziatore per gruppi, con rubinetto per lavatrice 3/4x3/4x3/4. C.P. brass washing machine bibcock, with connection, 3/4x3/4x3/4.



258RA € 6,40
 Raccordo distanziatore per gruppi, 3/4Mx3/4F. C.P. brass connection for mixers, 3/4Mx3/4F.



259 € 8,20
 Rubinetto a tre vie, sottolavabo, per attacco lavatrice, 1/2x3/4. C.P. three ways washing machine bibcock, brass model, 1/2x3/4.



260 € 6,00
 Rubinetto a sfera, a tre vie, sottolavabo, per attacco lavatrice, 1/2Mx1/2Fx3/4M. C.P. brass three ways washing machine mini ballvalve, 1/2Mx1/2Fx3/4M.



2611212 € 7,30
 Rubinetto a sfera, maniglia a farfalla, con rosetta in ottone cromato, 1/2x1/2. Angle valve with c.p. brass flange, 1/2x1/2.



Rubinetto a sfera per lavatrice, maniglia a farfalla, con rosetta in ottone cromato, 1/2x3/4, 3/8x3/4. C.P. brass hose bibcock for washing machine, with flange in C.P. brass, 1/2x3/4, 3/8x3/4.

26112 1/2x3/4 € 7,80
26138 3/8x3/4 € 7,50



261NR12 € 8,30
 Rubinetto a sfera, con valvola di non ritorno, con rosetta ottone cromato, 1/2x3/4. C.P. brass hose bibcock for washing machine, with flange in C.P. brass, 1/2x3/4, with no-return valve.



261E12 € 6,60
 Rubinetto a sfera per lavatrice, maniglia a leva, con rosetta in ottone cromato, 1/2x3/4. C.P. brass hose bibcock for washing machine, with flange in C.P. brass, 1/2x3/4.



Rubinetto a T normale, 3/8x3/4, 1/2x3/4. C.P. brass washing machine bibcock, 3/8x3/4, 1/2x3/4.

26512 1/2x3/4 € 7,60
26538 3/8x3/4 € 7,40



280 € 2,80
 Filtro per tubi carico lavatrice, 3/4Mx3/4F. C.P. filter for washing machine inlet hose, 3/4Mx3/4F.

FLESSIBILI
FLEXIBLE HOSES

MINUTERIA
MINUTERY

VALVOLE
VALVES

RACCORDERIA
FITTINGS

ACCESSORI
ACCESSORIES

COMPONENTI PLASTICI
PLASTIC COMPONENTS

ACCESSORI PER LAVATRICE - WASHING MACHINE ACCESSORIES



290

Tubo di carico per lavatrice, 3/4F x 3/4F.
Washing machine inlet hose, 3/4F x 3/4F.

cm	100	150	200	250	300
€	2,40	2,90	3,40	3,90	4,30



291

Tubo di carico per lavatrice, con curvetta, 3/4F x 3/4F.
Washing machine inlet hose, with elbow pipe, 3/4F x 3/4F.

cm	100	150	200	250	300	350	400	500
€	2,70	3,20	3,70	4,10	4,50	5,20	5,60	6,60



290BL

Tubo di carico per lavatrice, colore blu, 3/4F x 3/4F.
Washing machine inlet hose, blue colour, 3/4F x 3/4F.

cm	150	250	350
€	3,20	4,20	5,30



291BL

Tubo di carico per lavatrice, colore blu, con curvetta, 3/4F x 3/4F.
Washing machine inlet hose, blue colour, with elbow pipe, 3/4F x 3/4F.

cm	150	250	350
€	3,40	4,40	5,50



290RS

Tubo di carico per lavatrice, colore rosso, 3/4F x 3/4F.
Washing machine inlet hose, red colour, 3/4F x 3/4F.

cm	150	250	350	500
€	3,20	4,20	5,30	7,00



291RS

Tubo di carico per lavatrice, colore rosso, con curvetta, 3/4F x 3/4F.
Washing machine inlet hose, red colour, with elbow pipe, 3/4F x 3/4F.

cm	150	250	350	500
€	3,40	4,40	5,50	7,20



293

Tubo di carico in treccia acciaio inox gigante, 3/4F x 3/4F.
Washing machine stainless steel inlet hose, 3/4F x 3/4F.

cm	100	150	200	250
€	10,10	12,40	14,60	16,80



294

Tubo di carico in treccia acciaio inox gigante con curvetta, 3/4F x 3/4F.
Washing machine stainless steel inlet hose with elbow pipe, 3/4F x 3/4F.

cm	100	150	200	250
€	12,80	14,90	17,10	19,20



295

Tubo di carico con treccia in nylon bianco con banda grigia, 3/4F x 3/4F.
Washing machine braided in white nylon with grey stripes inlet hose, 3/4F x 3/4F.

cm	100	150	200	250
€	4,20	5,40	6,50	7,60



296

Tubo di carico con treccia in nylon bianco con banda grigia e curvetta, 3/4F x 3/4FC.
Washing machine braided in white nylon with grey stripes inlet hose and elbow pipe, 3/4F x 3/4FC.

cm	100	150	200	250
€	4,40	5,60	6,70	7,90



2950T

Tubo di carico con treccia in nylon bianco con banda grigia, 3/4F x 3/4F, con dadi in ottone nichelato.
Washing machine braided in white nylon with grey stripes inlet hose, 3/4F x 3/4F, with nickel plated brass nuts.

cm	100	150	200	250
€	8,30	9,50	10,50	11,70



2960T

Tubo di carico con treccia in nylon bianco con banda grigia e curvetta, 3/4F x 3/4FC, con dadi in ottone nichelato.
Washing machine braided in white nylon with grey stripes inlet hose with elbow pipe, 3/4F x 3/4FC, with nickel plated brass nuts.

cm	100	150	200	250
€	10,10	11,20	12,40	13,40

MINUTERIA - MINUTERY



300 € 3,80
Sifone di scarico per lavatrice, in plastica, con scarico ad innesto o a saldare, Ø mm 40.
Built-in washing machine siphon in black PEHD, outlet to weld or to insert Ø 40 mm.



300INC € 5,10
Sifone di scarico per lavatrice, in plastica, con scarico ad incollare, Ø mm 32, 40.
Built-in washing machine siphon in grey PVC, to glue Ø 32, 40 mm.



300X € 5,20
Sifone di scarico per lavatrice, in plastica, con piastra in acciaio INOX lucidato, con scarico ad innesto o a saldare, Ø mm 40.
Built-in washing machine siphon in black PEHD, with polished stainless steel flange, outlet to weld or to insert Ø 40 mm.



298 € 2,05
Raccordo a Y in propilene con dado girevole, 3/4Fx3/4Mx3/4M.
Y propylene connection with movable nut 3/4Fx3/4Mx3/4M.



297 € 0,26
Nipples in nylon, 3/4.
Nipples in nylon, 3/4



299 € 0,09
Guarnizione in gomma per tubo carico, 3/4.
Rubber washer for inlet hose, 3/4.



3081717
Giunto in nylon per tubi scarico.
Connection in nylon for waste tubes.

DIMENSIONI - SIZES	Ø 17x17	Ø 17x20	Ø 20x20
€	0,28	0,28	0,28



305SU € 0,21
Supporto in plastica per art. 305.
Plastic elbow holder for art. 305.



305B
Tubo di scarico per lavatrice in plastica spiralato, con raccordi Ø 22x29.
Washing machine outlet hose, in plastic, with connection Ø 22x29.

cm	100	150	200	250	300	350	400	500
€	1,50	1,75	2,05	2,40	2,60	3,00	3,60	4,20



305
Tubo di scarico per lavatrice, in plastica, spiralato.
Washing machine outlet hose, in plastic.

cm	100	150	200	250	300	350	400	500
€	1,30	1,50	1,85	2,05	2,40	2,80	3,25	4,00



306ES60 € 2,20
Tubo scarico lavatrice, in plastica estensibile da cm 60 a cm 200.
Extendable corrugate outlet hose for washing machine from cm 60 to cm 200.



306ES70 € 2,50
Tubo scarico lavatrice, in plastica estensibile da cm 70 a cm 270.
Extendable corrugate outlet hose for washing machine from cm 70 to cm 270.



305C
Tubo di scarico per lavatrice in plastica spiralato, con raccordo curvo.
Washing machine outlet hose, in plastic, with elbow connection.

cm	100	150	200	250	300	350	400	500
€	1,75	1,95	2,25	2,60	2,90	3,25	3,80	4,50

305BA
Tubo di scarico per lavatrice, in plastica, spiralato e supporto in plastica, Art 305+305SU in sacchetto.
Washing machine outlet hose, in plastic, with elbow holder, Art 305+305SU, in plastic bag.

cm	150	200	250	300
€	2,25	2,60	2,90	3,25

306ES120 € 4,30
Tubo scarico lavatrice, in plastica estensibile da cm 120 a cm 400.
Extendable corrugate outlet hose for washing machine from cm 120 to cm 400.

FLESSIBILI
FLEXIBLE HOSES

MINUTERIA
MINUTERY

VALVOLE
VALVES

RACCORDERIA
FITTINGS

ACCESSORI
ACCESSORIES

COMPONENTI PLASTICI
PLASTIC COMPONENTS



VALVOLE VALVES



VALVOLE - VALVES

FLESSIBILI
FLEXIBLE HOSES

MINUTERIA
MINUTERY

VALVOLE
VALVES

RACCORDERIA
FITTINGS

ACCESSORI
ACCESSORIES

COMPONENTI PLASTICI
PLASTIC COMPONENTS

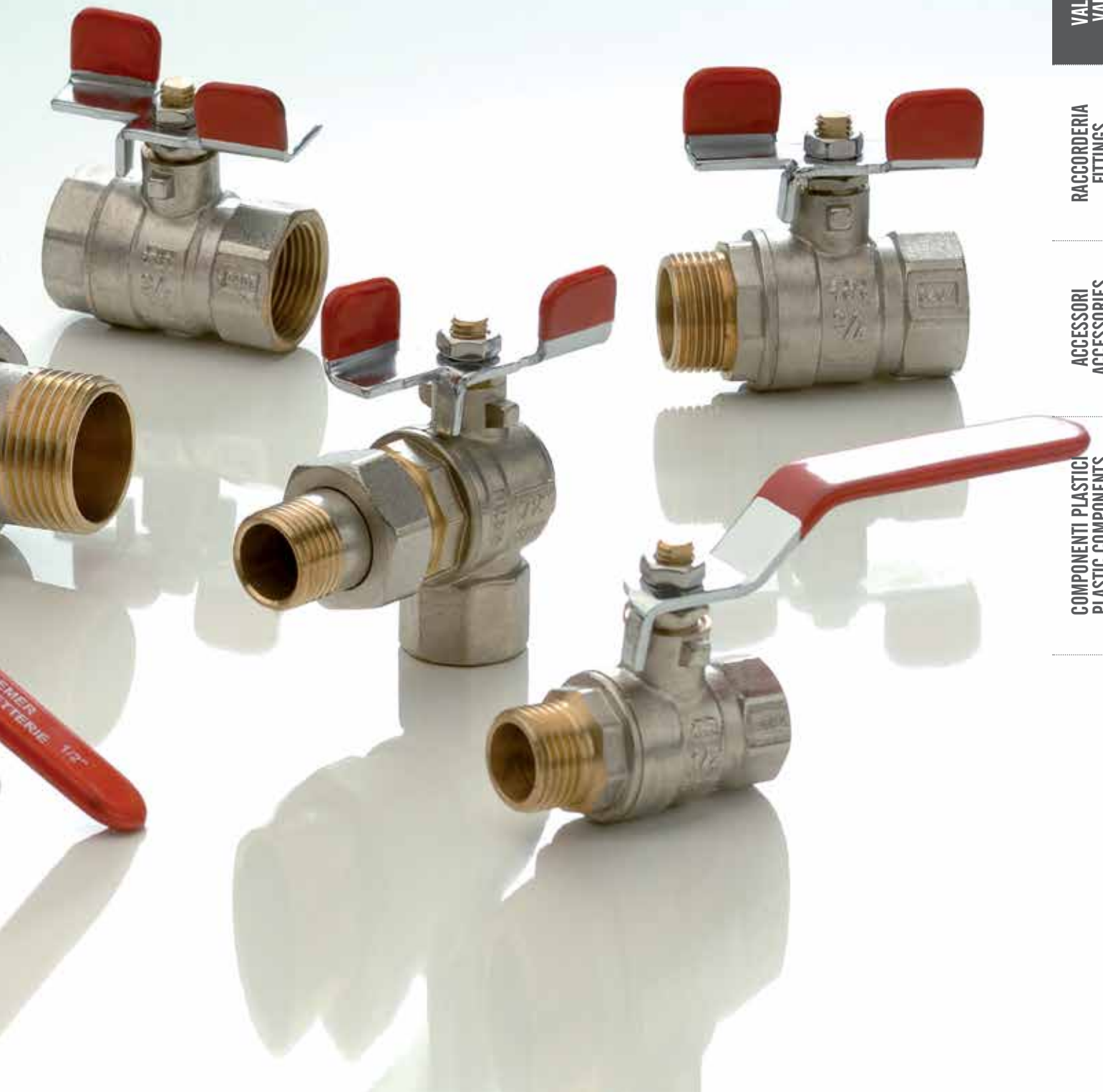

SERIE SEVEN | SEVEN SERIE

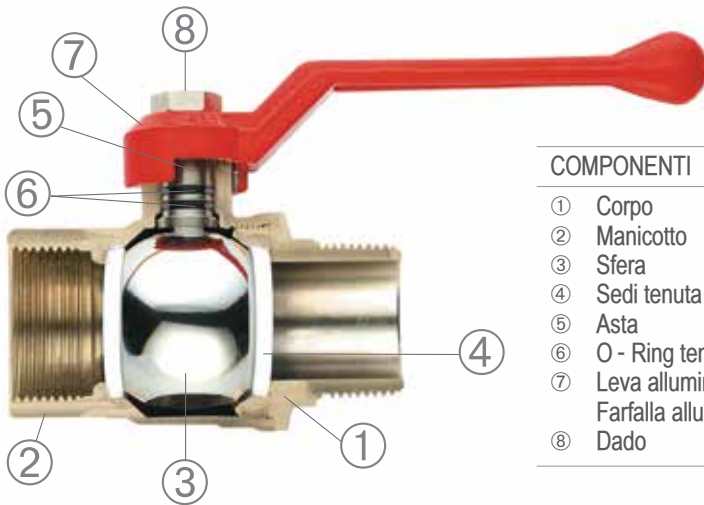

COMPONENTI	COMPONENTS	MATERIALI - MATERIALS
① Corpo	① Body	UNI EN 12165 CW617N
② Manicotto	② End connection	UNI EN 12165 CW617N
③ Sfera	③ Ball	UNI EN 12165 CW617N
④ Sedi tenuta sfera	④ Ball seal	P.T.F.E.
⑤ Asta	⑤ Stem	UNI EN 12164 CW614N
⑥ O - Ring tenuta asta	⑥ Rod seal O - Ring	NBR 70 Sh A (ASTM D 2240)
⑦ Leva alluminio	⑦ Alu handle	AL fire painted
Farfalla alluminio	Butterfly handle	AL fire painted
⑧ Dado	⑧ Nut	Chrome plated Brass

Condizioni d'esercizio: Temperatura: min -15, max +120 - Pressione nominale: max 40 bar.

- Passaggio: totale
- Gamma: da 1/2" a 2"
- Attacco femmina: filettatura ISO 7/1 Rp (parallela) (DIN 2999)
- Attacco maschio: filettatura ISO 7/1 R (conica) (DIN 2999)
- Codolo e dado: filettatura ISO 228/1 (DIN 259)

Working details: Temperature: min -15, max +120 - Nominal pressure: max 40 bar.

- Flow: full
- Range: from 1/2" till 2"
- Female thread: threading ISO 7/1 R (parallel) (DIN 2999)
- Male thread: threading ISO 7/1 R (conical) (DIN 2999)
- Connection fitting and nut: threading ISO 228/1 (DIN 259)

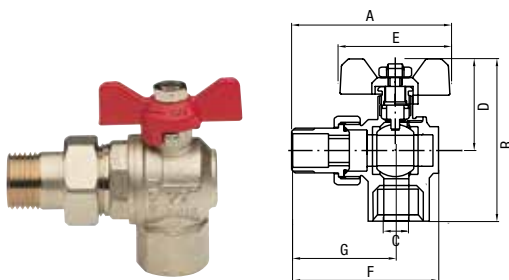
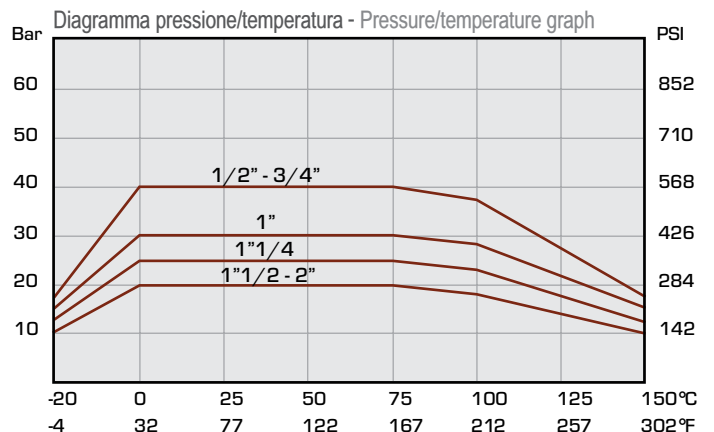
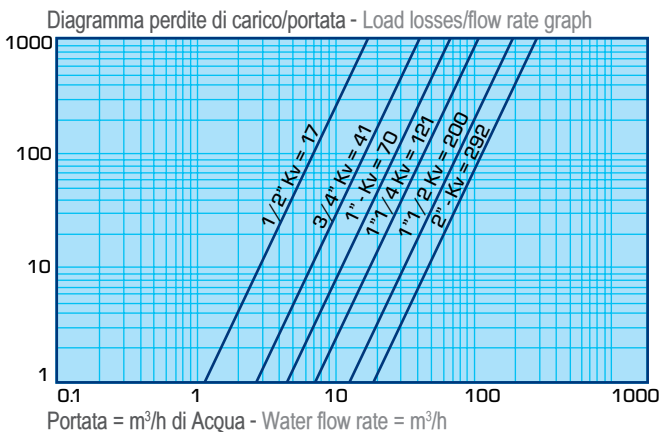

364C 1/2" € 8,90 3/4" € 14,00 1" € 24,40

Valvola a sfera ad angolo a sette filetti, con bocchettone, passaggio totale, maniglia a farfalla.
C.P. full-flow angle ball valve "seven threads", with union connection, with T handle.

	A	B	C	D	E	F	G
1/2"	87	53	15	37,5	51,5	91	61,5
3/4"	96,5	62,5	20	43,5	62	99	66,5
1"	109,5	70	25	46,5	62	118	78,5

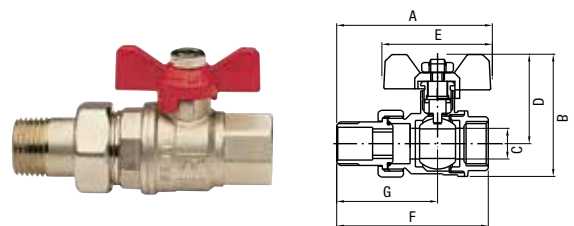

364 1/2" € 8,50 3/4" € 13,50 1" € 22,50

Valvola a sfera a sette filetti, con bocchettone, passaggio totale, maniglia a farfalla.
C.P. full-flow ball valve "seven threads", with union connection, with T handle.

	A	B	C	D	E	F	G
1/2"	84	69,5	13,8	38	51,5	74,5	58,5
3/4"	96,5	81,5	18,5	45	62	85,5	66
1"	111,5	93	23	48	62	103,5	80

SERIE RR | RR SERIE

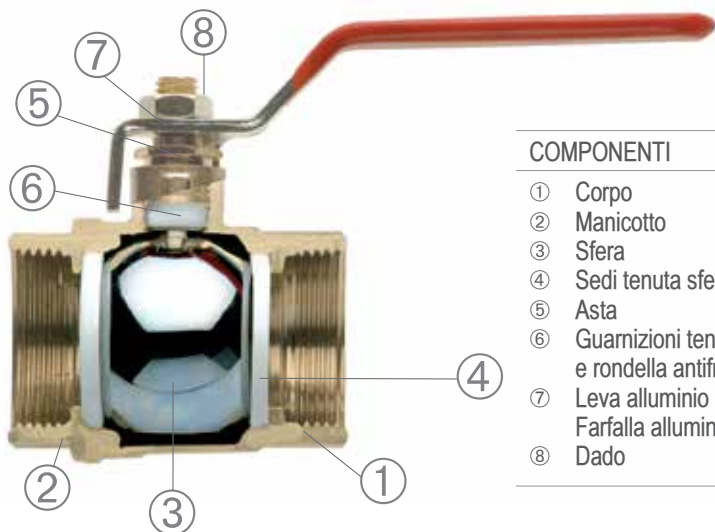

COMPONENTI	COMPONENTS	MATERIALI - MATERIALS
① Corpo	① Body	UNI EN 12165 CW617N
② Manicotto	② End connection	UNI EN 12165 CW617N
③ Sfera	③ Ball	UNI EN 12165 CW617N
④ Sedi tenuta sfera	④ Ball seal	P.T.F.E.
⑤ Asta	⑤ Stem	UNI EN 12164 CW614N
⑥ Guarnizioni tenuta asta e rondella antifrizione	⑥ Stem packing and antifriction ring	P.T.F.E.
⑦ Leva alluminio	⑦ Alu handle	AISI A3 PVC cover
⑧ Dado	⑧ Nut	AISI A3 PVC cover Chrome plated Brass

Condizioni d'esercizio: Temperatura: min -15, max +120 - Pressione nominale: max 40 bar.

- Passaggio: totale
- Gamma: da 1/2" a 2"
- Attacco femmina: filettatura ISO 228/1 (DIN 259)
- Attacco maschio: filettatura ISO 228/1 (conica) (DIN 259)
- Codolo e dado: filettatura ISO 228/1 (DIN 259)

Working details: Temperature: min -15, max +120 - Nominal pressure: max 40 bar.

- Flow: full
- Range: from 1/2" to 2"
- Female thread: threading ISO 228/1 (DIN 259)
- Male thread: threading ISO 228/1 (DIN 259)
- Connection fitting and nut: threading ISO 228/1 (DIN 259)

Diagramma perdite di carico/portata - Load losses/flow rate graph



Diagramma pressione/temperatura - Pressure/temperature graph



371RR 1/2" €5,40 3/4" €7,50 1" €12,70 1 1/4" €19,60
 1 1/2" €29,60 2" €40,80 2 1/2" €93,90 3" €121,10 4" €223,50

Valvola a sfera F.F. a passaggio totale, maniglia a leva, linea pesante e ottone visibile. C.p. full-flow RR ball valve F.F., heavy line and visible brass with lever handle.

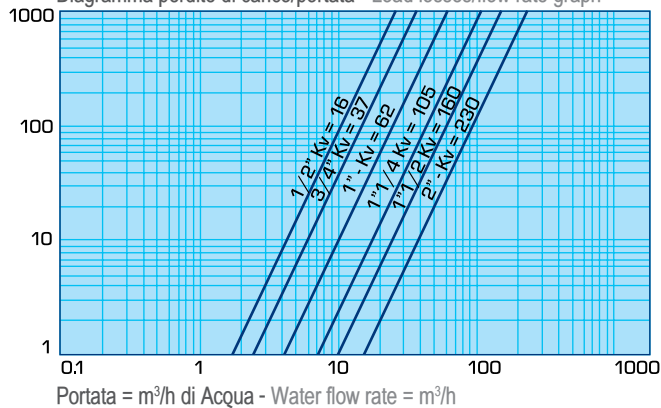
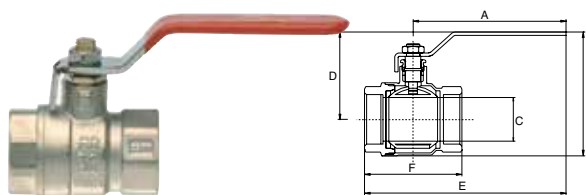
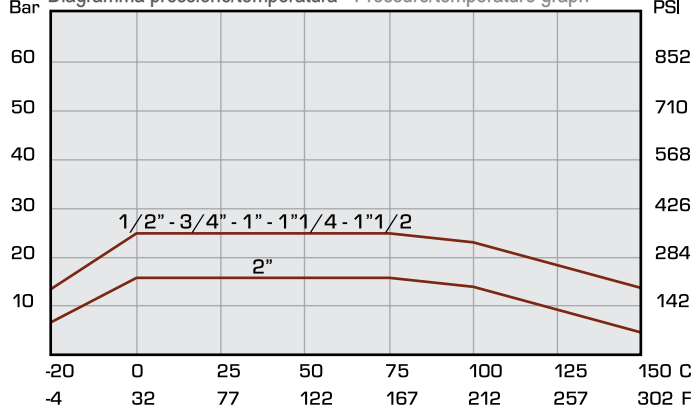
	A	B	C	D	E	F	G
1/2"	95	65	14,5	50	120	48	
3/4"	95	68	18,5	53	124	55	
1"	125	80	23	62	155	63	
1 1/4"	125	97	31,5	69	165	78	
1 1/2"	138	110	31,5	80	180	87	
2"	165	125	50	86	210	100	
2 1/2"	236		62	117	306	140	
3"	225		73	130	330	150	
4"	225		79	142,5	350	190	

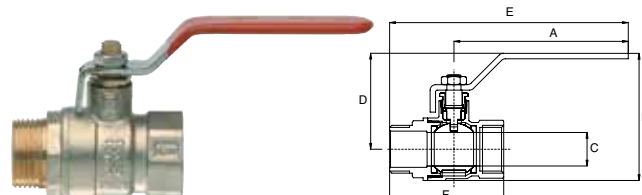

370RR 1/2" €5,90 3/4" €8,00 1" €13,70
 1 1/4" €21,10 1 1/2" €30,50 2" €44,80

Valvola a sfera M.F. a passaggio totale, maniglia a leva, linea pesante e ottone visibile. C.p. full-flow RR ball valve M.F. heavy line and visible brass with lever handle.

	A	B	C	D	E	F	G
1/2"	95	65	14,5	50	120	63	
3/4"	95	68	18,5	53	130	63	
1"	125	80	23	62	165	72	
1 1/4"	125	97	31,5	69	175	87	
1 1/2"	138	110	31,5	80	195	97	
2"	165	125	50	86	220	110	

FLESSIBILI
FLEXIBLE HOSES

MINUTERIA
MINUTERY

VALVOLE
VALVES

RACCORDERIA
FITTINGS

ACCESSORI
ACCESSORIES

COMPONENTI PLASTICI
PLASTIC COMPONENTS

SERIE FULL FLOW | FULL FLOW SERIE

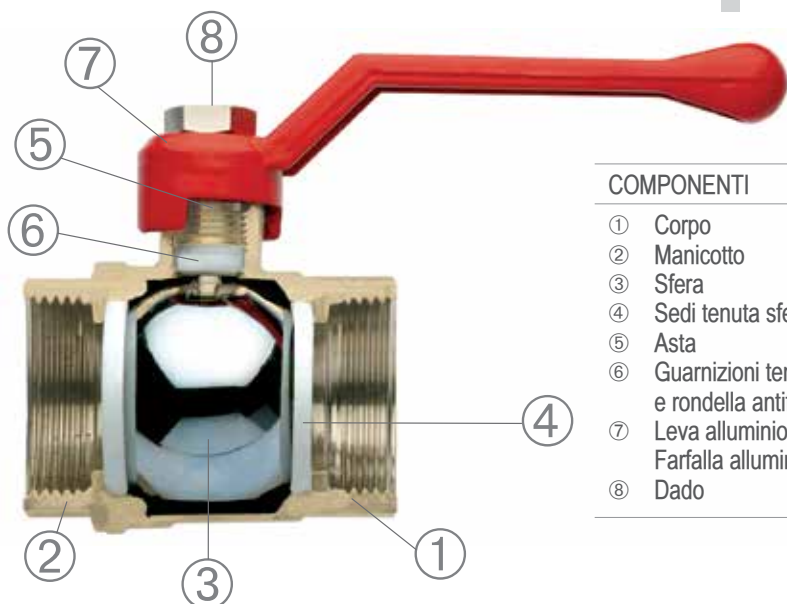

COMPONENTI	COMPONENTS	MATERIALI - MATERIALS
① Corpo	① Body	UNI EN 12165 CW617N
② Manicotto	② End connection	UNI EN 12165 CW617N
③ Sfera	③ Ball	UNI EN 12165 CW617N
④ Sedi tenuta sfera	④ Ball seal	P.T.F.E.
⑤ Asta	⑤ Stem	UNI EN 12164 CW614N
⑥ Guarnizioni tenuta asta e rondella antifrizione	⑥ Stem packing and antifriction ring	P.T.F.E.
⑦ Leva alluminio	⑦ Alu handle	AL fire painted
Farfalla alluminio	Butterfly handle	AL fire painted
⑧ Dado	⑧ Nut	Chrome plated Brass

Condizioni d'esercizio: Temperatura: min -15, max +120 - Pressione nominale: max 40 bar.

Working details: Temperature: min -15, max +120 - Nominal pressure: max 40 bar.

- Passaggio: totale
- Gamma: da 3/8" a 4"
- Attacco femmina: filettatura ISO 228/1 (DIN 259)
- Attacco maschio: filettatura ISO 228/1 (DIN 259)
- Codolo e dado: filettatura ISO 228/1 (DIN 259)

- Flow: full
- Range: from 3/8" till 4"
- Female thread: threading ISO 228/1 (DIN 259)
- Male thread: threading ISO 228/1 (DIN 259)
- Connection fitting and nut: threading ISO 228/1 (DIN 259)

Diagramma perdite di carico/portata
Load losses/flow rate graph

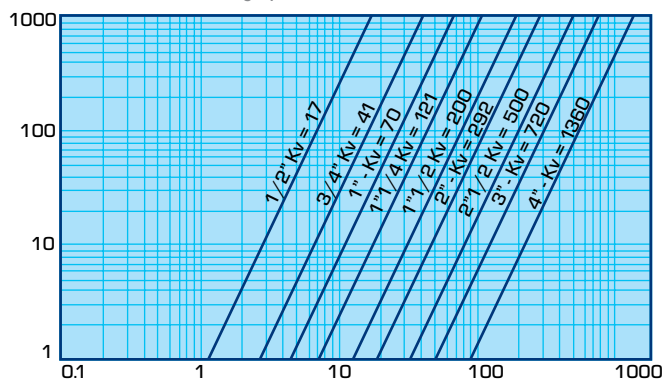

Portata = m³/h di Acqua
Water flow rate = m³/h

Diagramma pressione/temperatura
Pressure/temperature graph

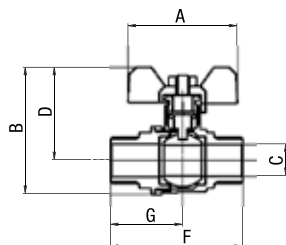
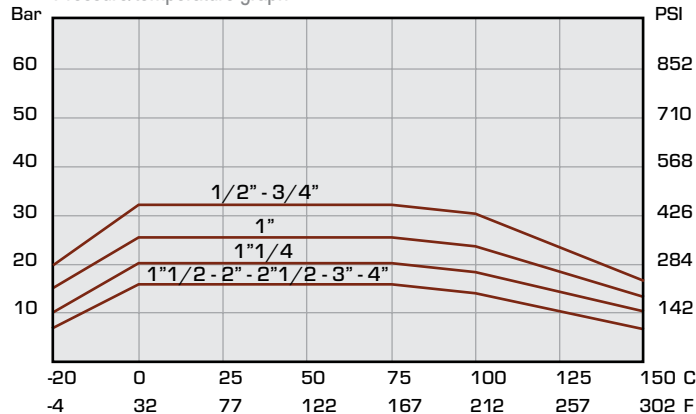

365MM 1/2 €5,70 3/4 €8,10 1" €13,30

Valvola a sfera M.M., a passaggio totale, maniglia a farfalla.
C.P. full-flow ball valve M.M. with T handle.

	A	B	C	D	E	F	G
1/2"	58,5	53	14,5	38	51	60,5	33
3/4"	61	57,8	18,5	40,5	51	68,5	35,5
1"	71	68,8	23,5	47,8	62	78	40

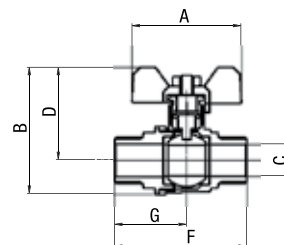

366 1/2 €6,80 3/4 €9,40 1" €15,60 1 1/4 €26,70

Valvola a sfera con bocchettone, a passaggio totale, maniglia a farfalla.
C.P. full-flow ball valve with union connection.

	A	B	C	D	E	F	G
1/2"	78	55	14	38	58	73	48
3/4"	85	60	19	42	58	82	55
1"	98	70	25	45	58	98	65
1 1/4"	110	87	25	60	77	110	72

VALVOLE - VALVES

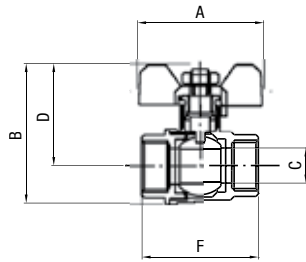

365FF 1/2" €5,20 3/4" €7,10 1" €11,70

Valvola a sfera F.F., a passaggio totale, maniglia a farfalla.
C.P. full-flow ball valve F.F. with T handle.

	A	B	C	D	E	F	G
1/2"	50	55	14	40		48	
3/4"	50	59	19	42		56	
1"	66	69	25	49		65	

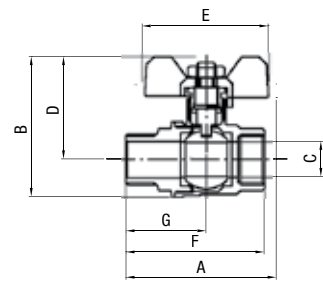

365 MF 1/2" €5,50 3/4" €7,40 1" €12,40

Valvola a sfera M.F., a passaggio totale, maniglia a farfalla.
C.P. full-flow ball valve M.F. with T handle.

	A	B	C	D	E	F	G
1/2"	68	55	14	40	58	57	34
3/4"	65	60	19	43	58	64	37
1"	72	67	24	48	66	72	41

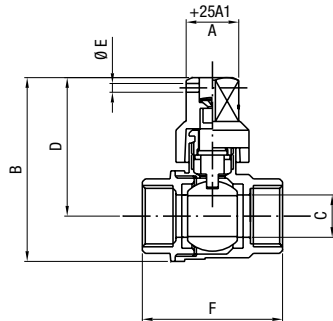

373FF 1/2" €5,90

Valvola a sfera F.F., a passaggio totale con quadro 13x13 bloccante piombabile.
C.P. full-flow ball valve F.F. with square cap 13x13.

	A	B	C	D	E	F	G
1/2"	14	63	14	47	3,2	48	

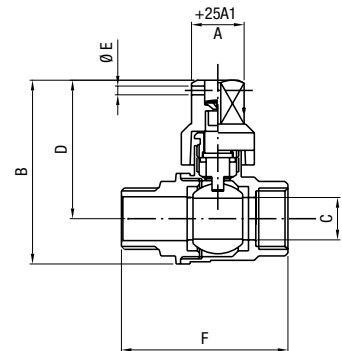

373MF 1/2" €6,80 3/4" €9,00 1" €13,90

Valvola a sfera M.F., a passaggio totale con quadro 13x13 bloccante piombabile.
C.P. full-flow ball valve M.F. with square cap 13x13.

	A	B	C	D	E	F	G
1/2"	14	65	14	47	3,2	64	
3/4"	14	68	19	50	3,2	63	
1"	16	75	24	53	3,2	71	

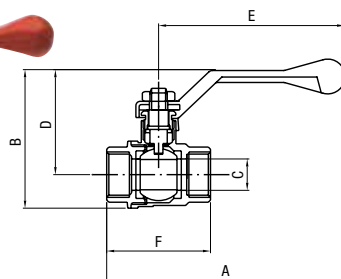

371 3/8" €4,10 1/2" €5,20 3/4" €7,10 1" €11,70 1 1/4" €18,60
1 1/2" €26,90 2" €40,50 2 1/2" €88,30 3" €113,90 4" €203,00

Valvola a sfera F.F., a passaggio totale, maniglia a leva.
C.P. full-flow ball valve F.F. with lever handle.

	A	B	C	D	E	F	G
3/8"	96	50	10	38	76	40	
1/2"	110	57	14	42	85	48	
3/4"	113	66	19	50	85	56	
1"	130	75	24	52	98	65	
1 1/4"	155	90	31	68	115	78	
1 1/2"	178	110	39	80	130	95	
2"	183	123	50	85	132	102	
2 1/2"	296	170	60	110	225	136	
3"	305	180	70	120	230	150	
4"	320	205	90	135	230	190	

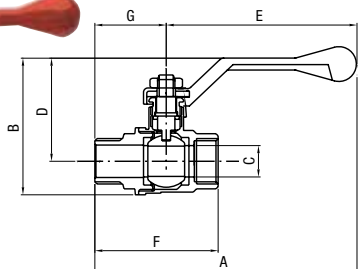

370 1/2" €5,50 3/4" €7,40 1" €12,40
1 1/4" €20,10 1 1/2" €27,70 2" €41,60

Valvola a sfera M.F., a passaggio totale, maniglia a leva.
C.P. full-flow ball valve M.F. with lever handle.

	A	B	C	D	E	F	G
1/2"	117	58	14	43	85	57	34
3/4"	120	62	19	44	85	63	37
1"	135	75	24	53	96	72	41
1 1/4"	165	93	30	68	118	88	50
1 1/2"	186	110	40	80	132	98	56
2"	195	125	50	83	132	112	62

FLESSIBILI
FLEXIBLE HOSES

MINUTERIA
MINUTERY

VALVOLE
VALVES

RACCORDERIA
FITTINGS

ACCESSORI
ACCESSORIES

COMPONENTI PLASTICI
PLASTIC COMPONENTS

SERIE STANDARD | STANDARD SERIE

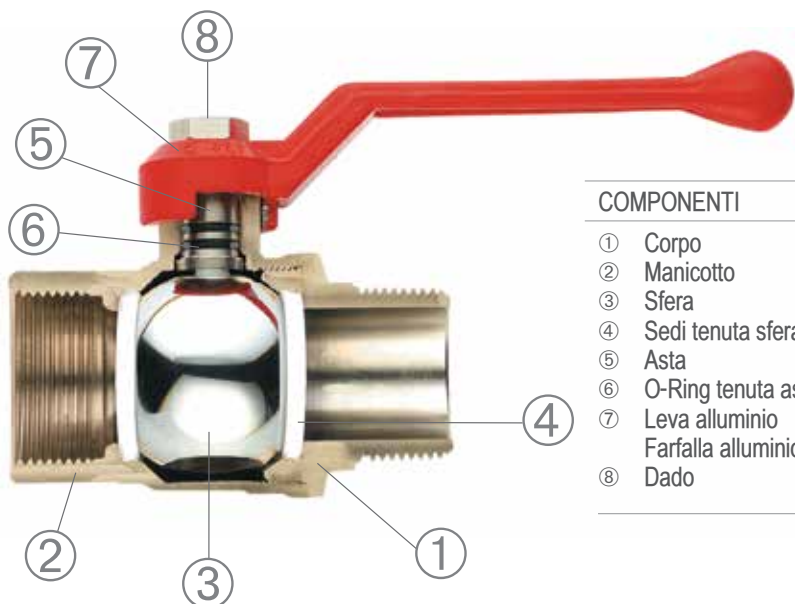

COMPONENTI	COMPONENTS	MATERIALI - MATERIALS
① Corpo	① Body	UNI EN 12165 CW617N
② Manicotto	② End connection	UNI EN 12165 CW617N
③ Sfera	③ Ball	UNI EN 12165 CW617N
④ Sedi tenuta sfera	④ Ball seal	P.T.F.E.
⑤ Asta	⑤ Stem	UNI EN 12164 CW614N
⑥ O-Ring tenuta asta	⑥ Rod seal O-Ring	NBR 70 Sh A (ASTM D 2240)
⑦ Leva alluminio	⑦ Alu handle	AL fire painted
Farfalla alluminio	Butterfly handle	AL fire painted
⑧ Dado	⑧ Nut	Chrome plated Brass

Condizioni d'esercizio: Temperatura: min -15, max +120 - Pressione nominale: max 40 bar.

Working details: Temperature: min -15, max +120 - Nominal pressure: max 40 bar.

- Passaggio: standard
- Gamma: da 1/2" a 2"
- Attacco femmina: filettatura ISO 228/1 (DIN 259)
- Attacco maschio: filettatura ISO 228/1 (DIN 259)

- Flow: standard
- Range: from 1/2" to 2"
- Female thread: threading ISO 228/1 (DIN 259)
- Male thread: threading ISO 228/1 (DIN 259)

Diagramma perdite di carico/portata
Load losses/flow rate graph

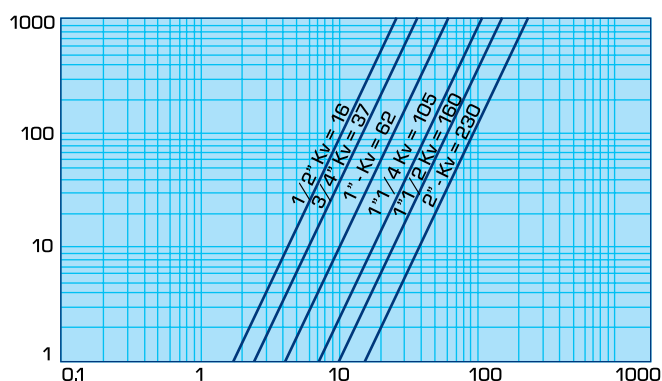

Portata = m³/h di Acqua
Water flow rate = m³/h

Diagramma pressione/temperatura
Pressure/temperature graph

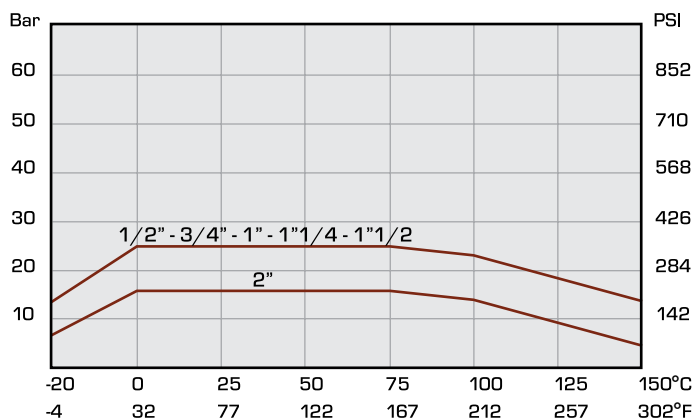

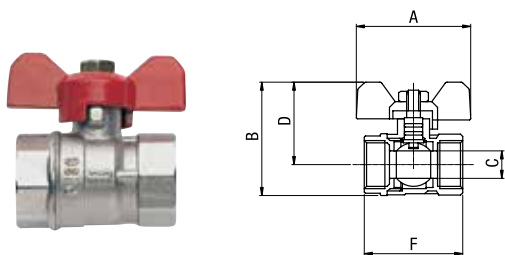

363FF 1/2 €4,40 3/4 €6,00

Valvola a sfera F.F., a passaggio standard, maniglia a farfalla, 1/2, 3/4, 1".
C.P. standard-flow ball valve F.F. with T handle, 1/2, 3/4, 1".

	A	B	C	D	E	F	G
1/2"	47	50	13,5	36	50	45	
3/4"	52	59	18	42	50	52	

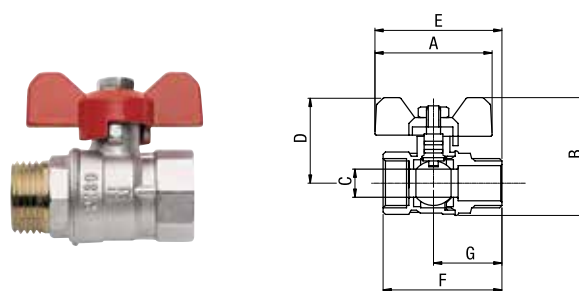

363MF 1/2 €4,80 3/4 €6,70 1" €11,70

Valvola a sfera M.F., a passaggio standard, maniglia a farfalla, 1/2, 3/4, 1".
C.P. standard-flow ball valve M.F. with T handle, 1/2, 3/4, 1".

	A	B	C	D	E	F	G
1/2"	47	50	13,5	36	50	45	
3/4"	52	59	18	42	50	52	
1"	64	72	23	51	65	63	

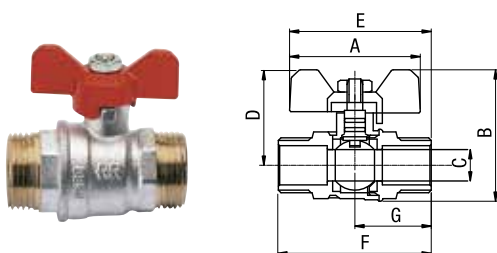

363MM 1/2 €5,00 3/4 €6,90 1" €12,20

Valvola a sfera M.M., a passaggio standard, maniglia a farfalla, 1/2, 3/4, 1".
C.P. standard-flow ball valve M.M. with T handle, 1/2, 3/4, 1".

	A	B	C	D	E	F	G
1/2"	51,5	51,8	13,8	37	54,6	53	29,2
3/4"	51,5	58,5	17,8	41	58,5	59,5	32,8
1"	63	71,5	23,5	50	71,3	77,5	40,5

FLESSIBILI
FLEXIBLE HOSES

MINUTERIA
MINUTERY

VALVOLE
VALVES

RACCORDERIA
FITTINGS

ACCESSORI
ACCESSORIES

COMPONENTI PLASTICI
PLASTIC COMPONENTS

SERIE REDUCE FLOW | REDUCE FLOW SERIE

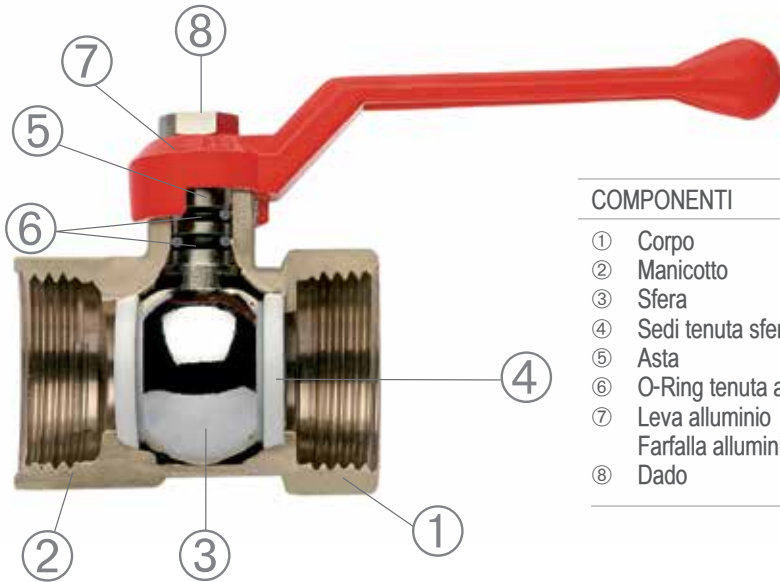

COMPONENTI	COMPONENTS	MATERIALI - MATERIALS
① Corpo	① Body	UNI EN 12165 CW617N
② Manicotto	② End connection	UNI EN 12165 CW617N
③ Sfera	③ Ball	UNI EN 12165 CW617N
④ Sedi tenuta sfera	④ Ball seal	P.T.F.E.
⑤ Asta	⑤ Stem	UNI EN 12164 CW614N
⑥ O-Ring tenuta asta	⑥ Rod seal O-Ring	NBR 70 Sh A (ASTM D 2240)
⑦ Leva alluminio Farfalla alluminio	⑦ Alu handle Butterfly handle	AL fire painted AL fire painted
⑧ Dado	⑧ Nut	Chrome plated Brass

Condizioni d'esercizio: Temperatura: min -15, max +120 - Pressione nominale: max 40 bar.

- Passaggio: ridotto
- Gamma: da 1/2" a 4"
- Attacco femmina: filettatura ISO 228/1 (DIN 259)
- Attacco maschio: filettatura ISO 228/1 (DIN 259)

Working details: Temperature: min -15, max +120 - Nominal pressure: max 40 bar.

- Flow: reduced
- Range: from 1/2" to 4"
- Female thread: threading ISO 228/1 (DIN 259)
- Male thread: threading ISO 228/1 (DIN 259)

Diagramma perdite di carico/portata - Load losses/flow rate graph

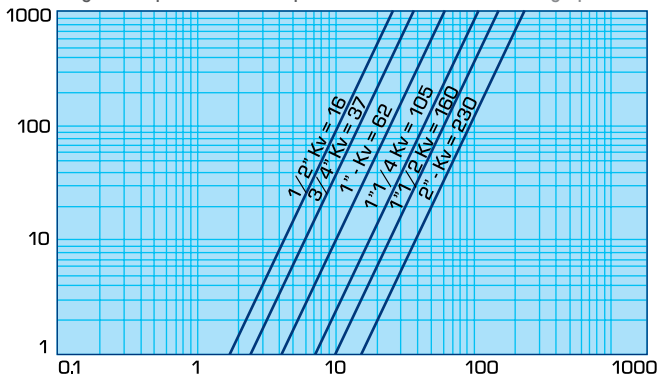

Portata = m³/h di Acqua - Water flow rate = m³/h

Diagramma pressione/temperatura - Pressure/temperature graph

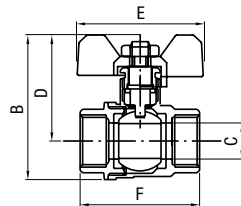
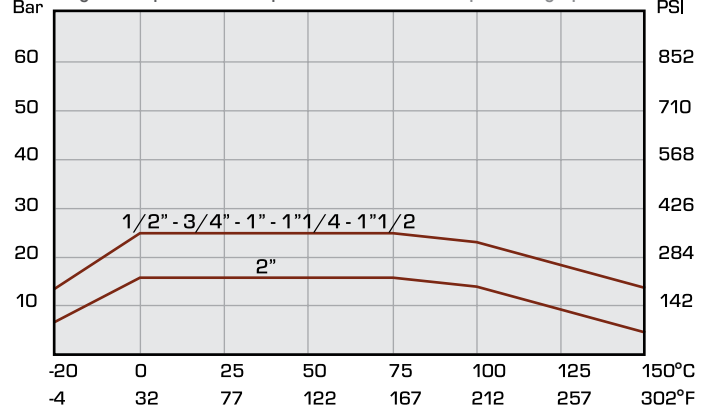

368FF 1/2" € 4,30 3/4" € 6,10 1" € 10,20

Valvola a sfera F.F. maniglia a farfalla.
C.P. ball valve F.F., with T handle.

	A	B	C	D	E	F	G
1/2"		47		33	58	44	
3/4"		53		36	58	48	
1"		61		42	67	60	

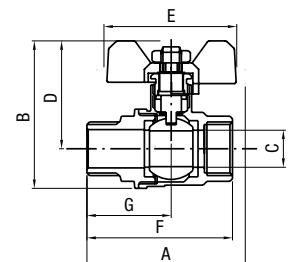

368MF 1/2" € 4,50 3/4" € 6,50

Valvola a sfera F.F. maniglia a farfalla.
C.P. ball valve F.F., with T handle.

	A	B	C	D	E	F	G
1/2"	61	46	12	33	58	53	32
3/4"	64	53	15	36	58	58	34

VALVOLE | VALVES

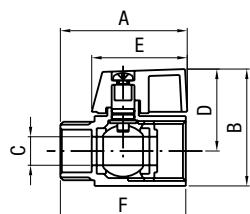
FLESSIBILI
FLEXIBLE HOSESMINUTERIA
MINUTERYVALVOLE
VALVESRACCORDERIA
FITTINGSACCESSORI
ACCESSORIESCOMPONENTI PLASTICI
PLASTIC COMPONENTS
372MF 1/4 € 4,30 3/8 € 4,40 1/2 € 4,70

 Valvola minisfera M.F., con maniglia nera.
 C.P. mini ball valve M.F. with black handle.

	A	B	C	D	E	F	G
1/4"	42	38	7,5	28	33	41	
3/8"	42	38	8	28	33	41	
1/2"	45	40	10	28	33	44	

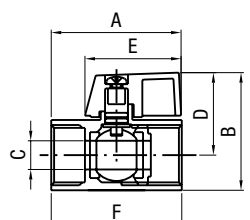
372FF 1/4 € 4,70 3/8 € 4,80 1/2 € 5,20

 Valvola minisfera F.F., con maniglia nera.
 C.P. mini ball valve F.F. with black handle.

	A	B	C	D	E	F	G
1/4"	44	38	7,5	28	33	42	
3/8"	44	38	8	28	33	42	
1/2"	45	40	10	28	33	45	

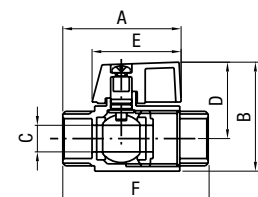
372MM 1/4 € 5,30 3/8 € 5,50 1/2 € 6,50

 Valvola minisfera M.M., con maniglia nera.
 C.P. mini ball valve M.M. with black handle.

	A	B	C	D	E	F	G
1/4"	42	38	7,5	28	33	54	
3/8"	42	38	8	28	33	55	
1/2"	45	40	10	28	33	59	

 Condizioni d'esercizio: Temperatura: min -15, max +120 - Pressione nominale: max 10 bar.
 Working details: Temperature: min -15, max +120 - Nominal pressure: max 10 bar.

372MF12NC € 5,00

 Valvola minisfera M.F. maniglia cromata e nera, 1/2.
 C.P. mini ball valve M.F. with two handles chromed and black, 1/2.

372FF12NC € 5,50

 Valvola minisfera F.F. maniglia cromata e nera, 1/2.
 C.P. mini ball valve F.F. with two handles chromed and black, 1/2.

372MF12RB € 5,00

 Valvola minisfera M.F. maniglia rossa e blu, 1/2.
 C.P. mini ball valve M.F. with two handles red and blue, 1/2.

372FF12RB € 5,50

 Valvola minisfera F.F. maniglia rossa e blu, 1/2.
 C.P. mini ball valve F.F. with two handles red and blue, 1/2.

VALVOLE- VALVES



376FI12

€ 30,10

Valvola a sfera con filtro, attacchi per manometro e scarico, con raccordo girevole da 1/2.
Ball valve with filter and connections for manometer and drain, with swivelling nut 1/2.



376NR12

€ 25,70

Valvola a sfera con valvolina di non ritorno, con attacchi per manometro e scarico, con raccordo girevole da 1/2.
Ball valve with non return valve and connections for manometer and drain, with swivelling nut 1/2.

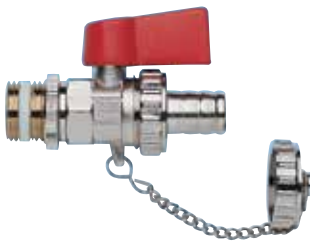
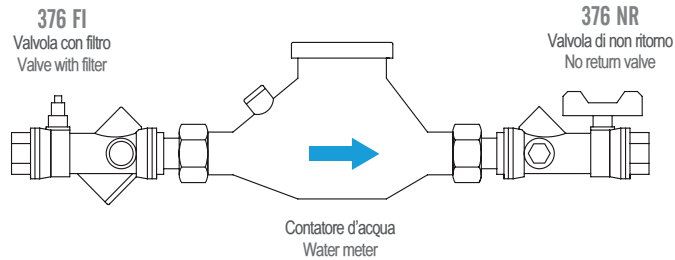

37712

€ 7,40

Rubinetto scarico caldaia, a sfera, nichelato 1/2.
Drain cock male connection with plug, nickel plated, 1/2.

	A	B	C	D	E	F	G
1/2"	77	52	10	15	35	36	



3770G12

€ 7,10

Rubinetto scarico caldaia, a sfera, in ottone giallo 1/2.
Drain cock male connection with plug, brass finish, 1/2.

	A	B	C	D	E	F	G
1/2"	77	52	10	15	35	36	

Condizioni d'esercizio: Temperatura: min 0, max +80 - Pressione nominale: max 12 bar.
Working details: Temperature: min 0, max +80 - Nominal pressure: max 12 bar.

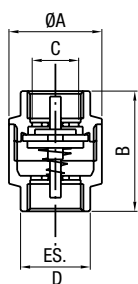

380
Valvola di ritegno.
REMER check valve.

1/2" € 5,10 1"1/4 € 14,20
3/4" € 7,40 1"1/2 € 21,40
1" € 9,90 2" € 32,70

	A	B	C	D	E	F	G
1/2"	35	45	19	25			
3/4"	40	48	24	32			
1"	47	56	30	37			
1" 1/4	59	61	39	46			
1" 1/2	67	70	45	53			
2"	83	75	55	67			

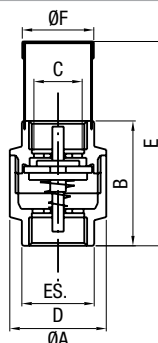

381
Valvola di fondo, con filtro.
REMER foot valve, with filter.

1/2" € 4,00 1"1/4 € 10,40
3/4" € 5,80 1"1/2 € 16,30
1" € 7,90 2" € 25,00

	A	B	C	D	E	F	G
1/2"	34	42	18	25	68	24	
3/4"	44	47	24	31	77	30	
1"	45	52	30	38	89	36	
1" 1/4	59	60	39	46	107	44	
1" 1/2	68	68	44	53	121	54	
2"	84	75	57	67	140	64	

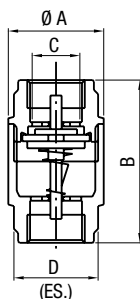

383
Valvola di ritegno STAR.
STAR check valve.

1/2" € 6,90 1"1/4 € 23,70
3/4" € 10,10 1"1/2 € 32,00
1" € 15,60 2" € 50,40

	A	B	C	D	E	F	G
1/2"	33	54	19	27			
3/4"	40	65	24	33			
1"	48	75	30	40			
1" 1/4	60	73	39	50			
1" 1/2	70	87	45	55			
2"	86	94	56	67			



384
Filtro per valvola STAR 1/2, 3/4,
1", 1"1/4, 1"1/2, 2".
Filter for STAR check valve 1/2,
3/4, 1", 1"1/4, 1"1/2, 2".

1/2" € 1,40 1"1/4 € 2,20
3/4" € 1,70 1"1/2 € 2,70
1" € 1,80 2" € 3,50

Condizioni d'esercizio: Temperatura: min 0, max +80 - Pressione nominale: max 12 bar.
Working details: Temperature: min 0, max +80 - Nominal pressure: max 12 bar.



385
Valvola di ritegno.
Foot valve, measures from 3/4 to 2".

3/4" € 10,00 1"1/2 € 23,90
1" € 12,60 2" € 36,30
1"1/4 € 19,60



388
Valvola a clapet con tenuta gomma, 1/2", 3/4", 1".
Swing check valve, with rubber sealing, from 1/2" to 1".

1/2" € 9,50 1" € 20,60
3/4" € 14,80



389
Filtro a "Y" in ottone, con rete 400 micron.
"Y" brass filter, with 400 micron strainer.

	A	B	C	D	E	F	G
1/2"	63	55	15				
3/4"	67	70	20				
1"	75	76	25				
1" 1/4	89	99	32				
1" 1/2	100	107	40				
2"	125	126	50				

Condizioni d'esercizio: Temperatura: min 0, max +100 - Pressione nominale: max 20 bar.
Working details: Temperature: min 0, max +100 - Nominal pressure: max 20 bar.

FLESSIBILI
FLEXIBLE HOSES

MINUTERIA
MINUTERY

VALVOLE
VALVES

RACCORDERIA
FITTINGS

ACCESSORI
ACCESSORIES

COMPONENTI PLASTICI
PLASTIC COMPONENTS

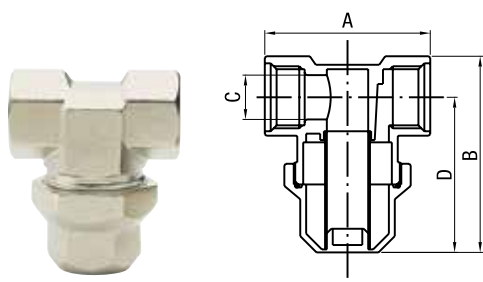

390FF12

Filtro di linea in ottone nichelato, con rete 400 micron, F.F.
In-line filter in nickel-plated brass, with 400 micron strainer, F.F.

1/2 €11,50

	A	B	C	D	E	F	G
1/2"	60	70	13,5	54			

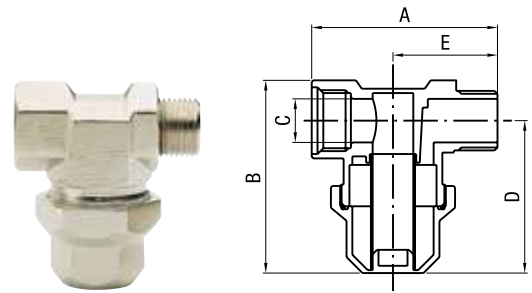

390MF12

Filtro di linea in ottone nichelato, con rete 400 micron, M.F.
In-line filter in nickel-plated brass, with 400 micron strainer, M.F.

1/2 €11,50

	A	B	C	D	E	F	G
1/2"	66	70	13,5	54	36		

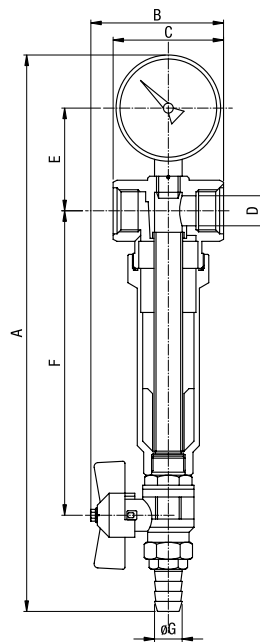

392

Filtro autopulente per fluidi, con rete 100 micron, 1/2, 3/4.
Self-cleaning filter for fluids, 100 micron strainer, 1/2, 3/4.

1/2 €43,30

3/4 €53,40

	A	B	C	D	E	F	G
1/2"	290	70	60	19	60	157	14
3/4"	290	77	60	24	62	150	14

SERIE YELLOW | YELLOW SERIE



400FF

Tubo flessibile per gas, FF, conforme alla norma EN14800, tubo interno in acciaio inox, ricoperto da trecciatura inox e rivestito da una guaina in pvc.

Flexible tube for gas, FF, conform to EN14800, internal tube in stainless steel, external braided in stainless steel and covered in pvc.

cm	50	75	100	125	150	200
	€ 26,80	€ 31,60	€ 34,20	€ 37,30	€ 38,40	€ 40,20



400MF

Tubo flessibile per gas, MF, conforme alla norma EN14800, tubo interno in acciaio inox, ricoperto da trecciatura inox e rivestito da una guaina in pvc.

Flexible tube for gas, MF, conform to EN14800, internal tube in stainless steel, external braided in stainless steel and covered in pvc..

cm	50	75	100	125	150	200
	€ 26,80	€ 31,60	€ 34,20	€ 37,30	€ 38,40	€ 40,20



400FFRI

prodotto non vendibile in italia

Tubo gas inox estensibile ricoperto in polietilene termoretraibile a norma UNI CIG 9891 con marchio IMQ, per collegamento di apparecchiature domestiche.

Flexible extensible stainless steel hose, suitable for domestic use gas connections, in accordance with UNI-CIG 9891, IMQ, covered with yellow thermoshrinking sleeving.

1/2 FF	50-100 cm	75-150 cm	100-200 cm
	€ 19,60	€ 23,60	€ 27,50



400MFRI

prodotto non vendibile in italia

Tubo gas inox estensibile ricoperto in polietilene termoretraibile a norma UNI CIG 9891 con marchio IMQ, per collegamento di apparecchiature domestiche.

Flexible extensible stainless steel hose, suitable for domestic use gas connections, in accordance with UNI-CIG 9891, IMQ, covered with yellow thermoshrinking sleeving .

1/2 MF	50-100 cm	75-150 cm	100-200 cm
	€ 19,60	€ 23,60	€ 27,50

FLESSIBILI
FLEXIBLE HOSESMINUTERIA
MINUTERYVALVOLE
VALVESRACCORDERIA
FITTINGSACCESSORI
ACCESSORIESCOMPONENTI PLASTICI
PLASTIC COMPONENTS

SERIE YELLOW - YELLOW SERIE



440

Tubo inox estensibile antivibrante, adatto per gas, acqua, olii, acidi, aria, vapore.
Stainless steel extensible anti-vibration pipe, suitable for gas, water, oils, acids, air, steam.

	Lunghezza - Length mm 110-210	Lunghezza - Length mm 200-410
1/2 MF	€ 10,50	€ 12,70
3/4 MF	€ 15,20	€ 17,70
1" MF	€ 22,00	€ 24,10



440 RI

Tubo inox estensibile rivestito in polietilene termoretraibile.
Stainless steel extensible pipe, covered with heat-shrinkable polyethylene.

	Lunghezza - Length mm 110-210	Lunghezza - Length mm 200-410
1/2 MF	€ 13,30	€ 16,10
3/4 MF	€ 18,00	€ 22,20



400GU

Guarnizione in alluminio, 1/2" per art. 400.
Washer in aluminium, 1/2" for art. 400.

€ 0,09



400RA

Raccordo maschio da 1/2".
Rackord male 1/2" for art. 400.

€ 9,90



400CH

Maniglia con filetto da 1/2" maschio per estendere l'art. 400, più chiave di fissaggio.
Lever with 1/2" male thread to extend art. 400 and its fixing key.

€ 4,90



397

Tubo gas a norme UNI CIG 7140 - IMQ, Ø 8x13, per gas liquido GPL, in rotoli da mt 50.
Tube for liquid gas GPL, UNI CIG 7140 and IMQ standard rules, Ø 13x8mm, in rolls of 50 meters.

€ 1,40



398

Tubo gas a norme UNI CIG 7140 - IMQ, Ø 13x20, per gas METANO, in rotoli da mt 50.
Tube for natural gas, UNI CIG 7140 and IMQ standard rules, Ø 13x20 mm, in rolls of 50 meters.

€ 2,40

VALVOLE - VALVES

FLESSIBILI
FLEXIBLE HOSES

MINUTERIA
MINUTERY

VALVOLE
VALVES

RACCORDERIA
FITTINGS

ACCESSORI
ACCESSORIES

COMPONENTI PLASTICI
PLASTIC COMPONENTS



40112 €18,30
Rubinetto a sfera a squadra per gas metano, cromato M, 1/2.
C.P. angle ball valve for natural gas, 1/2M.



40212 €18,30
Rubinetto a sfera a squadra per gas metano, cromato F, 1/2.
C.P. angle ball valve for natural gas, 1/2F.



40312 €18,30
Rubinetto a sfera a squadra per gas liquido GPL, cromato M, 1/2.
C.P. angle ball valve for liquid gas GPL, 1/2M.



40412 €18,30
Rubinetto a sfera a squadra per gas liquido GPL, cromato F, 1/2.
C.P. angle ball valve for liquid gas GPL, 1/2F.



40512 1/2 €18,30
Rubinetto a sfera diritto per gas metano, cromato M, 1/2.
C.P. straight ball valve for natural gas, 1/2M.



40612 €18,30
Rubinetto a sfera diritto per gas metano, cromato F, 1/2.
C.P. straight ball valve for natural gas, 1/2F.



40712 €18,30
Rubinetto a sfera diritto per gas liquido GPL, cromato M, 1/2.
C.P. straight ball valve for liquid gas GPL, 1/2M.



40812 €18,30
Rubinetto a sfera diritto per gas liquido GPL, cromato F, 1/2.
C.P. straight ball valve for liquid gas GPL, 1/2F.



39912 €10,00
Rubinetto gas a sfera a squadra passaggio mm 12,5 con maniglia a farfalla, 1/2 MM.
Angle ball valve for natural gas with T handle, flow Ø 12,5, 1/2M.



411M12 €15,20
Rubinetto a sfera a squadra per gas, con dado girevole, cromato, M 1/2.
C.P. angle ball valve for gas, with swivelling nut, M 1/2.



411F12 €15,20
Rubinetto a sfera a squadra per gas, con dado girevole, cromato, F 1/2.
C.P. angle ball valve for gas, with swivelling nut, F 1/2.



RACCORDERIA FITTINGS



RACCORDERIA - FITTINGS

FLESSIBILI
FLEXIBLE HOSES

MINUTERIA
MINUTERY

VALVOLE
VALVES

RACCORDERIA
FITTINGS

ACCESSORI
ACCESSORIES

COMPONENTI PLASTICI
PLASTIC COMPONENTS



RACCORDERIA - FITTINGS



413N12 € 7,10
Valvola sicurezza scaldabagno normale MF, 1/2.
Safety valve for water heaters, normal type, MF 1/2.



413P812 € 9,00
Valvola sicurezza scaldabagno pesante tarata 8 atmosfere MF 3/8, 1/2.
Safety valve for water heaters, heavy type, set for 8 atmospheres, MF, 3/8, 1/2.



41212 € 11,70
Valvola sicurezza scaldabagno pesante MF, 1/2.
Safety valve for water heaters, heavy type, MF 1/2.



41512 € 24,00
Riduttore di pressione nichelato FF 1/2.
Nickel plated brass pressure reducer, FF 1/2.



Riduttore di pressione in ottone giallo con bocchettoni.
Yellow heavy brass pressure reducer, with union connection.

415CB12MM	1/2" M x 1/2" M	€ 57,00
415CB34MM	3/4" M x 3/4" M	€ 61,30
415CB10MM	1" M x 1" M	€ 113,90



418 € 5,40
Manometro Ø mm 63, con attacco radiale 1/4, 10 bar.
Pressure gauge Ø 63 mm, 1/4" radial connection, 10 bar.



418P € 5,60
Manometro Ø mm 63, con attacco posteriore (assiale) 1/4, 10 bar.
Pressure gauge Ø 63 mm, with rear connection (axial) 1/4, 10 bar.



433
Valvola sfiato aria automatica con galleggiante 3/8, 1/2.
Automatic drain plug for radiator, with floating system, 3/8, 1/2.

3/8	1/2
€ 9,10	€ 9,10



420L10 € 11,20
Raccordo a 5 vie per pompa-autoclave, lunghezza mm 92, 1".
5 Ways connector for pumps and tanks, length 92 mm, 1".



461
Bocchettone a 3 pezzi diritto, in ottone giallo.
Straight coupler in 3 pieces, yellow brass.

1/2	3/4	1"	1 1/4"
€ 3,30	€ 5,50	€ 10,40	€ 12,70



461CR
Bocchettone a 3 pezzi diritto, in ottone cromato.
Straight coupler in 3 pieces, C.P. brass.

1/2	3/4	1"	1 1/4"
€ 3,50	€ 5,90	€ 11,00	€ 13,60



462
Bocchettone a 3 pezzi curvo, in ottone giallo.
Angle coupler in 3 pieces, yellow brass.

1/2	3/4	1"	1 1/4"
€ 4,70	€ 7,00	€ 12,60	€ 18,90



462CR
Bocchettone a 3 pezzi curvo, in ottone cromato.
Angle coupler in 3 pieces, C.P. brass.

1/2	3/4	1"	1 1/4"
€ 5,00	€ 7,60	€ 13,30	€ 20,20



471
Raccordo per cassone con tappo.
Flanged connector for cistern with plug.

1/2	3/4	1"
€ 5,20	€ 8,00	€ 11,30



473
Raccordo per cassone diritto.
Straight connector for cistern.

1/2	3/4	1"
€ 7,90	€ 11,90	€ 16,70



472
Raccordo per cassone con codulo.
Flanged connector for cistern with union.

1/2	3/4	1"
€ 6,90	€ 9,70	€ 13,30



474
Controdado con flangia.
Backnut in brass.

1/2	3/4	1"
€ 1,10	€ 2,20	€ 2,50

RACCORDI IN OTTONE - BRASS FITTINGS



451
Gomito M.F. in ottone cromato.
Elbow M.F., in C.P. brass.

M.F.	3/8	1/2	3/4	1"	1 1/4	1 1/2	2"
€	2,70	3,40	4,70	7,10	13,90	20,40	38,90



451NP
Gomito M.F. in ottone nichelato.
Elbow M.F., in nickel brass.

M.F.	3/8	1/2	3/4	1"	1 1/4	1 1/2	2"
€	2,20	2,80	4,10	6,60	12,60	20,00	37,30



4510G
Gomito M.F. in ottone giallo.
Elbow M.F., in yellow brass.

M.F.	3/8	1/2	3/4	1"	1 1/4	1 1/2	2"
€	2,10	2,70	3,90	6,10	12,20	18,50	36,20



452
Gomito F.F. in ottone cromato.
Elbow F.F., in C.P. brass.

F.F.	3/8	1/2	3/4	1"	1 1/4	1 1/2	2"
€	2,80	3,40	4,90	7,10	13,90	17,60	29,80



452NP
Gomito F.F. in ottone nichelato.
Elbow F.F., in nickel brass.

F.F.	3/8	1/2	3/4	1"	1 1/4	1 1/2	2"
€	2,30	2,80	4,30	6,60	12,60	15,90	28,70



4520G
Gomito F.F. in ottone giallo.
Elbow F.F., in yellow brass.

F.F.	3/8	1/2	3/4	1"	1 1/4	1 1/2	2"
€	2,20	2,70	4,10	6,10	12,20	15,70	28,10



453
TE in ottone cromato.
Tee in chrome plated brass.

TE	3/8	1/2	3/4	1"	1 1/4	1 1/2	2"
€	3,20	3,60	5,20	7,50	15,20	22,80	35,70



453NP
TE in ottone nichelato.
Tee in nickel brass.

TE	3/8	1/2	3/4	1"	1 1/4	1 1/2	2"
€	2,70	3,00	4,80	7,00	13,60	21,20	33,40



4530G
TE in ottone giallo.
Tee in yellow brass.

TE	3/8	1/2	3/4	1"	1 1/4	1 1/2	2"
€	2,60	2,90	4,40	6,60	13,30	20,60	32,70



454
Manicotto F.F. in ottone cromato.
Sleeve F.F. in chrome plated brass.

F.F.	3/8	1/2	3/4	1"	1 1/4	1 1/2	2"
€	1,60	1,80	2,20	3,50	7,60	10,80	13,20



454NP
Manicotto F.F. in ottone nichelato.
Sleeve F.F. in nickel brass.

F.F.	3/8	1/2	3/4	1"	1 1/4	1 1/2	2"
€	1,50	1,60	2,10	3,20	7,10	9,60	12,10



4540G
Manicotto F.F. in ottone giallo.
Sleeve F.F. in yellow brass.

F.F.	3/8	1/2	3/4	1"	1 1/4	1 1/2	2"
€	1,40	1,50	1,90	2,90	6,80	9,20	11,60



502
Prolunghe in ottone cromato, con broccia.
C.P. brass extension.

mm	3/8	1/2	3/4	1"
10	€1,30	€1,10	€2,00	
15	€1,60	€1,40	€2,60	€4,00
20	€2,00	€1,60	€3,40	€4,40
25	€2,40	€1,90	€4,10	€5,00
30	€2,80	€2,10	€4,30	€6,00
40	€3,10	€2,60	€5,20	€7,10
50	€3,50	€3,00	€6,10	€8,30
60		€4,20	€6,90	
80		€5,40	€8,70	
100		€6,30	€10,30	



502 OG
Prolunghe in ottone giallo con broccia.
Yellow brass extension.

mm	3/8	1/2	3/4	1"
10	€1,10	€0,91	€2,00	
15	€1,30	€1,20	€2,30	€3,50
20	€1,70	€1,40	€3,00	€3,90
25	€2,20	€1,60	€3,70	€4,50
30	€2,50	€1,90	€4,00	€5,30
40	€2,70	€2,40	€4,90	€6,40
50	€3,20	€2,70	€5,70	€7,50
60		€4,00	€6,50	
80		€5,10	€8,20	
100		€5,70	€9,80	



502P
Prolunghe in ottone cromato tipo pesante, Ø mm 27, con broccia.
Heavy c.p. brass extension, Ø mm 27.

1/2	10 mm	15 mm	20 mm	25 mm	30 mm	40 mm	50 mm	60 mm	80 mm	100 mm
€	1,40	1,70	2,00	2,40	2,60	3,40	4,00	5,60	7,30	8,50



502POG
Prolunghe in ottone giallo tipo pesante Ø mm 27, con broccia.
Heavy yellow brass extension Ø mm 27.

1/2	10 mm	15 mm	20 mm	25 mm	30 mm	40 mm	50 mm	60 mm	80 mm	100 mm
€	1,20	1,50	1,80	2,10	2,40	3,00	3,70	5,30	6,80	7,90

FLESSIBILI
FLEXIBLE HOSES

MINUTERIA
MINUTERY

VALVOLE
VALVES

RACCORDERIA
FITTINGS

ACCESSORI
ACCESSORIES

COMPONENTI PLASTICI
PLASTIC COMPONENTS

RACCORDERIA - FITTINGS



506

Prolunghe ridotte in ottone cromato.
Round C.P. brass reduced extension.

1/4x3/8	1/4x1/2	3/8x1/2	3/8x3/4
€ 1,45	€ 1,70	€ 1,40	€ 2,00
1/2x3/4	1/2x1"	1/2x1"1/4	3/4x1"
€ 1,80	€ 3,80	€ 6,70	€ 2,50
3/4x1"1/4	3/4x1"1/2	1"x1"1/4	1"x1"1/2
€ 6,70	€ 7,70	€ 7,20	€ 8,50
1"x2"	1"1/4x1"1/2	1"1/4x2"	1"1/2x2"
€ 12,50	€ 9,10	€ 12,90	€ 12,10



506NP

Prolunghe ridotte in ottone nichelato.
Round nickel brass reduced extension.

1/4x3/8	1/4x1/2	3/8x1/2	3/8x3/4
€ 1,30	€ 1,50	€ 1,30	€ 1,90
1/2x3/4	1/2x1"	1/2x1"1/4	3/4x1"
€ 1,60	€ 3,60	€ 6,20	€ 2,10
3/4x1"1/4	3/4x1"1/2	1"x1"1/4	1"x1"1/2
€ 6,20	€ 7,40	€ 7,20	€ 8,00
1"x2"	1"1/4x1"1/2	1"1/4x2"	1"1/2x2"
€ 12,30	€ 9,20	€ 12,80	€ 12,30



5060G

Prolunghe ridotte in ottone giallo.
Round yellow brass reduced extension.

1/4x3/8	1/4x1/2	3/8x1/2	3/8x3/4
€ 1,20	€ 1,45	€ 1,20	€ 1,80
1/2x3/4	1/2x1"	1/2x1"1/4	3/4x1"
€ 1,50	€ 3,30	€ 5,70	€ 2,00
3/4x1"1/4	3/4x1"1/2	1"x1"1/4	1"x1"1/2
€ 5,70	€ 7,00	€ 6,80	€ 7,60
1"x2"	1"1/4x1"1/2	1"1/4x2"	1"1/2x2"
€ 11,70	€ 8,70	€ 12,10	€ 11,70



510

Manicotto ridotto F.F. in ottone cromato.
Reduced sleeve F.F. in C.P. brass.

1/4x3/8	3/8x1/2	3/8x1"	1/2x3/4
€ 2,10	€ 2,10	€ 4,40	€ 2,50
1/2x1"	1/2x1"1/4	1/2x1"1/2	3/4x1"
€ 5,30	€ 7,50	€ 9,90	€ 5,00
3/4x1"1/4	3/4x1"1/2	3/4x2"	1"x1"1/4
€ 7,90	€ 9,30	€ 14,40	€ 8,50
1"x1"1/2	1"x2"	1"1/4x1"1/2	1"1/4x2"
€ 10,90	€ 14,50	€ 10,50	€ 14,40



510NP

Manicotto ridotto F.F. in ottone nichelato.
Reduced sleeve F.F. in nickel brass.

1/4x3/8	3/8x1/2	3/8x1"	1/2x3/4
€ 1,90	€ 1,90	€ 5,10	€ 2,40
1/2x1"	1/2x1"1/4	1/2x1"1/2	3/4x1"
€ 4,60	€ 7,30	€ 9,50	€ 4,60
3/4x1"1/4	3/4x1"1/2	3/4x2"	1"x1"1/4
€ 7,60	€ 9,00	€ 14,10	€ 8,20
1"x1"1/2	1"x2"	1"1/4x1"1/2	1"1/4x2"
€ 10,40	€ 14,10	€ 10,50	€ 14,10



5100G

Manicotto ridotto F.F. in ottone giallo.
Reduced sleeve F.F. in yellow brass.

1/4x3/8	3/8x1/2	3/8x1"	1/2x3/4
€ 1,80	€ 1,80	€ 4,80	€ 2,20
1/2x1"	1/2x1"1/4	1/2x1"1/2	3/4x1"
€ 4,30	€ 6,90	€ 9,00	€ 4,30
3/4x1"1/4	3/4x1"1/2	3/4x2"	1"x1"1/4
€ 7,20	€ 8,50	€ 13,40	€ 7,90
1"x1"1/2	1"x2"	1"1/4x1"1/2	1"1/4x2"
€ 9,90	€ 13,40	€ 10,00	€ 13,40



511

Riduzioni esagonali in ottone cromato.
Hexagonal reducing piece in chrome plated brass.

1/4x3/8	1/4x1/2	1/4x3/4	3/8x1/2
€ 0,90	€ 1,30	€ 2,00	€ 0,93
3/8x3/4	3/8x1"	1/2x3/4	1/2x1"
€ 2,10	€ 3,90	€ 1,60	€ 3,30
1/2x1"1/4	1/2x1"1/2	1/2x2"	3/4x1"
€ 8,50	€ 11,00	€ 15,60	€ 2,50
3/4x1"1/4	3/4x1"1/2	3/4x2"	1"x1"1/4
€ 7,20	€ 10,20	€ 14,20	€ 6,60
1"x1"1/2	1"x2"	1"1/4x1"1/2	1"1/4x2"
€ 8,90	€ 13,70	€ 6,50	€ 11,50



511NP

Riduzioni esagonali in ottone nichelato.
Hexagonal reducing piece in nickel brass.

1/4x3/8	1/4x1/2	1/4x3/4	3/8x1/2
€ 0,75	€ 1,20	€ 1,90	€ 0,80
3/8x3/4	3/8x1"	1/2x3/4	1/2x1"
€ 1,70	€ 3,60	€ 1,40	€ 3,05
1/2x1"1/4	1/2x1"1/2	1/2x2"	3/4x1"
€ 8,00	€ 10,40	€ 15,60	€ 2,20
3/4x1"1/4	3/4x1"1/2	3/4x2"	1"x1"1/4
€ 7,20	€ 9,80	€ 14,00	€ 5,80
1"x1"1/2	1"x2"	1"1/4x1"1/2	1"1/4x2"
€ 8,40	€ 13,50	€ 6,00	€ 11,10



5110G

Riduzioni esagonali in ottone giallo.
Hexagonal reducing piece in yellow brass.

1/4x3/8	1/4x1/2	1/4x3/4	3/8x1/2
€ 0,72	€ 1,10	€ 1,80	€ 0,69
3/8x3/4	3/8x1"	1/2x3/4	1/2x1"
€ 1,60	€ 3,40	€ 1,30	€ 2,90
1/2x1"1/4	1/2x1"1/2	1/2x2"	3/4x1"
€ 7,50	€ 9,90	€ 14,80	€ 2,10
3/4x1"1/4	3/4x1"1/2	3/4x2"	1"x1"1/4
€ 6,80	€ 9,30	€ 13,30	€ 5,50
1"x1"1/2	1"x2"	1"1/4x1"1/2	1"1/4x2"
€ 8,00	€ 12,80	€ 5,70	€ 10,50



515

Viti doppie ridotte in ottone cromato.
Reduced nipple in C.P. brass.

1/4x3/8	1/4x1/2	3/8x1/2	3/8x3/4
€ 1,30	€ 1,60	€ 1,30	€ 2,30
1/2x3/4	1/2x1"	1/2x1"1/4	3/4x1"
€ 2,10	€ 5,30	€ 6,90	€ 4,20
3/4x1"1/4	3/4x1"1/2	1"x1"1/4	1"x1"1/2
€ 6,80	€ 10,30	€ 8,50	€ 10,10
1"x2"	1"1/4x1"1/2	1"1/4x2"	1"1/2x2"
€ 13,40	€ 9,90	€ 12,90	€ 12,70



515NP

Viti doppie ridotte in ottone nichelato.
Reduced nipple in nickel brass.

1/4x3/8	1/4x1/2	3/8x1/2	3/8x3/4
€ 1,15	€ 1,50	€ 1,20	€ 2,10
1/2x3/4	1/2x1"	1/2x1"1/4	3/4x1"
€ 1,90	€ 4,30	€ 6,30	€ 3,60
3/4x1"1/4	3/4x1"1/2	1"x1"1/4	1"x1"1/2
€ 6,10	€ 9,70	€ 7,70	€ 9,60
1"x2"	1"1/4x1"1/2	1"1/4x2"	1"1/2x2"
€ 12,90	€ 9,50	€ 12,40	€ 12,20



5150G

Viti doppie ridotte in ottone giallo.
Reduced nipple in yellow brass.

1/4x3/8	1/4x1/2	3/8x1/2	3/8x3/4
€ 1,10	€ 1,35	€ 1,10	€ 2,00
1/2x3/4	1/2x1"	1/2x1"1/4	3/4x1"
€ 1,80	€ 4,20	€ 6,00	€ 3,40
3/4x1"1/4	3/4x1"1/2	1"x1"1/4	1"x1"1/2
€ 5,80	€ 9,20	€ 7,50	€ 9,10
1"x2"	1"1/4x1"1/2	1"1/4x2"	1"1/2x2"
€ 12,40	€ 9,00	€ 11,90	€ 11,70

RACCORDERIA - FITTINGS



515L

Viti doppie ridotte in ottone cromato, con 7 filetti.
Reduced nipple in C.P. brass, with 7 threads.

3/8x1/2	1/2x3/4
€ 2,60	€ 4,40



515LNP

Viti doppie ridotte in ottone nichelato, con 7 filetti.
Reduced nipple in nickel brass, with 7 threads.

3/8x1/2	1/2x3/4
€ 2,42	€ 4,20



515LOG

Viti doppie ridotte in ottone giallo, con 7 filetti.
Reduced nipple in yellow brass, with 7 threads.

3/8x1/2	1/2x3/4
€ 2,30	€ 4,00

FLESSIBILI
FLEXIBLE HOSES

MINUTERIA
MINUTERY



520

Viti doppie in ottone cromato.
Double nipple in c.p. brass.

3/8	1/2	3/4	1"	1"1/4	1"1/2	2"
€ 0,97	€ 1,20	€ 2,10	€ 3,70	€ 8,60	€ 9,90	€ 11,30



520NP

Viti doppie in ottone nichelato.
Double nipple in nickel brass.

3/8	1/2	3/4	1"	1"1/4	1"1/2	2"
€ 0,82	€ 1,05	€ 2,00	€ 3,60	€ 8,00	€ 9,30	€ 10,90



5200G

Viti doppie in ottone giallo.
Double nipple in yellow brass.

3/8	1/2	3/4	1"	1"1/4	1"1/2	2"
€ 0,78	€ 0,99	€ 1,90	€ 3,40	€ 7,60	€ 8,80	€ 10,30

VALVOLE
VALVES



520L

Viti doppie in ottone cromato, con 7 filetti.
Double nipple in c.p. brass, with 7 threads.

1/2	3/4
€ 2,70	€ 5,00



520LNP

Viti doppie in ottone nichelato, con 7 filetti.
Double nipple in nickel brass, with 7 threads.

1/2	3/4
€ 2,42	€ 4,62



520LOG

Viti doppie in ottone giallo, con 7 filetti.
Double nipple in yellow brass, with 7 threads.

1/2	3/4
€ 2,30	€ 4,40

RACCORDERIA
FITTINGS

ACCESSORI
ACCESSORIES



523

Tappi esagonali in ottone cromato.
Hexagonal plug in c. p. brass.

3/8	1/2	3/4	1"
€ 0,75	€ 0,96	€ 1,60	€ 2,90



523NP

Tappi esagonali in ottone nichelato.
Hexagonal plug in nickel brass.

3/8	1/2	3/4	1"
€ 0,59	€ 0,72	€ 1,40	€ 2,90



5230G

Tappi esagonali in ottone giallo.
Hexagonal plug in yellow brass.

3/8	1/2	3/4	1"
€ 0,56	€ 0,69	€ 1,30	€ 2,70

COMPONENTI PLASTICI
PLASTIC COMPONENTS



524

Calotte esagonali in ottone cromato.
Hexagonal cap in c. p. brass.

3/8	1/2	3/4	1"
€ 0,63	€ 0,86	€ 1,40	€ 2,00
1"1/4	1"1/2	2"	
€ 4,70	€ 6,30	€ 10,20	



524NP

Calotte esagonali in ottone nichelato.
Hexagonal cap in nickel brass.

3/8	1/2	3/4	1"
€ 0,45	€ 0,66	€ 1,30	€ 1,80
1"1/4	1"1/2	2"	
€ 4,00	€ 5,70	€ 9,70	



5240G

Calotte esagonali in ottone giallo.
Hexagonal cap in yellow brass.

3/8	1/2	3/4	1"
€ 0,43	€ 0,63	€ 1,20	€ 1,70
1"1/4	1"1/2	2"	
€ 3,80	€ 5,40	€ 9,20	

VITI DOPPIE - DOUBLE NIPPLES



52112 €1,60
Vite doppia in ottone cromato mm 36, 1/2".
Double nipple in c.p. brass mm 36, 1/2".



521NP12 €1,37
Vite doppia in ottone nichelato mm 36, 1/2".
Double nipple in nickel brass mm 36, 1/2".



5210G12 €1,30
Vite doppia in ottone giallo mm 36, 1/2".
Double nipple in yellow brass mm 36, 1/2".



52112L €2,10
Vite doppia in ottone cromato prolungata mm 50, 1/2".
Double nipple in c.p. brass mm 50, extended 1/2".



521NP12L €1,89
Vite doppia prolungata in ottone nichelato mm 50, 1/2".
Double nipple in nickel brass mm 50, extended 1/2".



5210G12L €1,80
Vite doppia prolungata in ottone giallo mm 50, 1/2".
Double nipple in yellow brass mm 50, extended 1/2".

PORTAGOMMA - HOSE HOLDER



53112 €2,80
Portagomma diritto in ottone cromato Ø 14 mm, attacco M, 1/2.
Straight hose holder in c.p. brass Ø 14 mm, Male connection, 1/2.



53212 €2,90
Portagomma diritto in ottone cromato Ø 14 mm, attacco F, 1/2.
Straight hose holder in c.p. brass Ø 14 mm, Female connection, 1/2.



53312 €2,30
Portagomma diritto in ottone cromato Ø 9 mm, attacco M, 1/2.
Straight hose holder in c.p. brass Ø 9 mm, Male connection, 1/2.



53412 €2,30
Portagomma diritto in ottone cromato Ø 9 mm, attacco F, 1/2.
Straight hose holder in c.p. brass Ø 9 mm, Female connection, 1/2.



53612 €4,40
Portagomma curvo in ottone cromato Ø 15 mm, attacco M, 1/2.
Elbow hose holder in c.p. brass Ø 15 mm, Male connection, 1/2.



53712 €3,80
Portagomma curvo in ottone cromato Ø 15 mm, attacco F, 1/2.
Elbow hose holder in c.p. brass Ø 15 mm, Female connection, 1/2.



53812 €3,70
Portagomma curvo in ottone cromato Ø 10 mm, attacco M, 1/2.
Elbow hose holder in c.p. brass Ø 10 mm, Male connection, 1/2.



53912 €3,20
Portagomma curvo in ottone cromato Ø 10 mm, attacco F, 1/2.
Elbow hose holder in c.p. brass Ø 10 mm, Female connection, 1/2.

RACCORDI - FITTINGS



5300G

Barilotti in ottone giallo, confezione da 10 pezzi.
Yellow brass extension screws, packing of 10 pieces.

mm	60	80	100	120	150	200	300	500
1/2	€ 2,40	€ 3,30	€ 4,00	€ 4,80	€ 5,90	€ 7,60	€ 11,60	€ 19,60
3/4	€ 3,60	€ 4,70	€ 5,60	€ 6,60	€ 8,20	€ 10,70	€ 16,40	€ 27,50
1"	€ 5,40	€ 7,20	€ 9,10	€ 11,00	€ 11,90	€ 16,60	€ 25,90	€ 45,20



529

Raccordo tutto filettato in ottone cromato.
C.p. brass extension full threaded.

1/2	30 mm	50 mm	60 mm	65 mm	80 mm	100 mm
€	2,50	3,20	3,90	4,20	4,80	5,30



5290G

Raccordo tutto filettato in ottone giallo.
Yellow brass extension full threaded.

1/2	30 mm	50 mm	60 mm	65 mm	80 mm	100 mm
€	2,00	2,50	2,90	3,00	3,60	4,10

FLESSIBILI
FLEXIBLE HOSES

MINUTERIA
MINUTERY

RACCORDI IN ACCIAIO ZINCATO - GALVANIZED FITTINGS



501

Prolunghe in acciaio zincato.
Galvanized steel extensions.

mm	10	15	20	25	30
3/8	€ 0,51	€ 0,56	€ 0,63	€ 0,79	€ 0,86
1/2	€ 0,48	€ 0,50	€ 0,55	€ 0,74	€ 0,78
3/4	€ 0,87	€ 0,93	€ 1,20	€ 1,40	€ 1,50



506AZ

Prolunghe ridotte in acciaio zincato.
Reduced extension round, galvanized steel.

1/4x3/8	3/8x1/2	1/2x3/4	3/4x1"
€ 0,71	€ 0,66	€ 0,90	€ 2,10



511AZ

Riduzioni esagonali in acciaio zincato.
Hexagonal reduced extension, galvanized steel.

1/4x3/8	3/8x1/2	1/2x3/4	3/4x1"
€ 0,57	€ 0,67	€ 0,79	€ 1,70



515AZ

Viti doppie ridotte in acciaio zincato.
Reduced nipple, galvanized steel.

1/4x3/8	3/8x1/2	1/2x3/4	3/4x1"
€ 0,63	€ 0,79	€ 1,40	€ 2,30



520AZ

Viti doppie esagonali in acciaio zincato.
Hexagonal double nipple in galvanized steel.

1/4"	3/8"	1/2"	3/4"	1"
€ 0,54	€ 0,55	€ 0,56	€ 1,30	€ 2,30



522AZ

Manicotti FF in acciaio zincato.
Sleeve FF in galvanized steel.

3/8"	1/2"	3/4"
€ 0,88	€ 0,90	€ 1,40

VALVOLE
VALVES

RACCORDERIA
FITTINGS

ACCESSORI
ACCESSORIES

COMPONENTI PLASTICI
PLASTIC COMPONENTS



530

Barilotti in acciaio zincato, confezioni da 10 pezzi.
Galvanized steel extension screws, packing of 10 pieces.

mm	60 mm	80 mm	100 mm	120 mm	150 mm	200 mm	300 mm	500 mm
1/2	€ 1,30	€ 1,40	€ 1,70	€ 2,00	€ 2,10	€ 2,40	€ 3,20	€ 6,40
3/4	€ 1,40	€ 1,70	€ 2,00	€ 2,20	€ 2,40	€ 3,50	€ 4,10	€ 5,90
1"	€ 2,00	€ 2,10	€ 2,40	€ 2,80	€ 3,20	€ 4,00	€ 5,40	€ 8,60

SERIE 495 | 495 SERIE

TUBO MULTISTRATO RR PEX - MULTILAYER PIPE RR PEX



Tubo multistrato RR PEX.
Multilayer pipe RR PEX.



Tubo multistrato RR PEX ricoperto con polietilene espanso, mm 6.
Multilayer pipe RR PEX covered with expanded polyethylene, mm 6.

495

Art.	Dimensione/Size	Rotolo/Rolls m	€
49516	Ø 16x2 mm	100 m	€ 1,50
49520	Ø 20x2 mm	100 m	€ 2,10
49526	Ø 26x3 mm	50 m	€ 4,20
49532	Ø 32x3 mm	50 m	€ 5,30

495R

Art.	Dimensione/Size	Rotolo/Rolls m	€
49516R	Ø 16x2 mm	50 m	€ 2,40
49520R	Ø 20x2 mm	50 m	€ 3,00

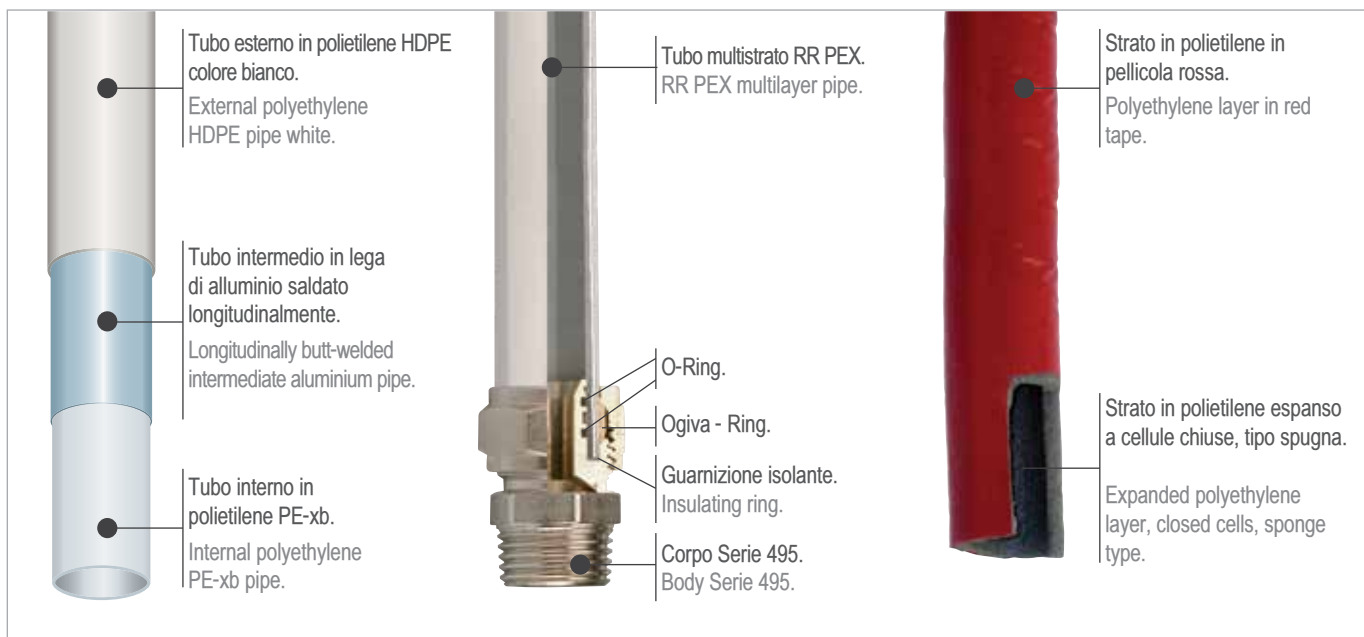

495CE € 19,10
Cesoia taglia tubo.
Pipe cutter.



495SB € 25,80
Calibratore per tubo.
Pipe plug gauge.

Analisi del tubo multistrato RR PEX Secondo UNI 10954-1 Analysis of the multilayer pipe RR PEX Conform to UNI 10954-1

FLESSIBILI
FLEXIBLE HOSES

MINUTERIA
MINUTERY

VALVOLE
VALVES

RACCORDERIA
FITTINGS

ACCESSORI
ACCESSORIES

COMPONENTI PLASTICI
PLASTIC COMPONENTS

ESAME DIMENSIONALE

Misure di spessore degli strati del tubo:

Art.	Dn esterno	Dn interno	S parete n	Tolleranza	Strato esterno media Um	Strato intermedio media Um	Strato interno media Um
495 16	16	12	2	± 0,2	700	300	1.000
495 20	20	16	2	± 0,15	680	320	1.000
495 26	26	20	3	± 0,1	1.085	385	1.530
495 32	32	26	3	± 0,15	900	385	1.715

DIMENSIONAL TEST

Measurement of the thickness of the layers:

Gli spessori e le tolleranze degli strati sono conformi a quanto previsto per la serie S, punto 7 UNI 10954/1 prospetti 2/3.

La serie S di appartenenza ad ogni misura è la seguente (16 x 2 = S26) (20 x 2 - 26 x 3 - 32 x 3 corrispondono alla serie S 34,5 / 42.8).

Thicknesses and tolerances of layers are in accordance with the same regulation as S serie, point 7 UNI 10954/1 prospects 2/3.

The S serie belonging to each measure is the following (16 x 2 = S26) (20 x 2 - 26 x 3 - 32 x 3 correspond to S serie 34,5 / 42.8).

Determinazione della resistenza alla pressione idrostatica secondo UNI 10954-1:2004 e caratteristiche meccaniche.

La prova è stata condotta secondo la norma UNI EN 921:1995 nelle seguenti condizioni:

Determination of the resistance to the hydrostatic pressure following UNI 10954-1:2004 and mechanical features.

The test has been driven following the rule UNI EN 921:1995 in following conditions:

Pressione idrostatica impostata	20,5 bar (prevista 19,73)
Classe di appartenenza dichiarata	2
Temperatura di prova impostata	95°C
Natura dell'ambiente di prova	Acqua
Tamponi utilizzati	Tipo A
Lunghezza libera del tubo	200 mm.
Durata della prova	1008 h (prevista 1000 h)
Posizione provino	Verticale

Set hydrostatic pressure	20,5 bar (norm testing up to 19,73)
Declared class of belonging	2
Set test temperature	95°C
Nature of the testing environment	Water
Plugs used	Type A
Free length of the tube	200 mm.
Testing time	1008 h (norm testing 1000 h)
Testing position	Vertical

Incertezza di misura espressa come deviazione std.: pressione ±0,1 bar, temperatura ±1,4°C.

The uncertainty of measure is expressed as derivation from std.: pressure ±0,1 bar, temperature ±1,4°C.

I risultati ottenuti sono i seguenti:

The results obtained are the followings:

REQUISITO PROVA TEST REQUIREMENT	VALORE OTTENUTO VALUE OBTAINED	ESITO DELLA PROVA TEST RESULT	TIPO DI ROTTURA KIND OF BREAKING
NESSUNA ROTTURA PER LA DURATA PROVA NO BREAKING FOR ALL THE TESTING TIME	Nessuna rottura No breaking	Positivo Positive	-- --

Caratteristiche fisiche e chimiche

Grado di reticolazione dello strato interno dei test di controllo eseguito sui campioni a norma UNI EN 579 Art 495 16 = 66,4%_ Art 495 20 = 65,8%_ Art 495 26 = 65,7% _ Art 495 32 = 65,6%.

Grado di reticolazione dello strato esterno dei test di controllo eseguiti sui campioni a norma UNI EN 579 Art 495 16 =1,5%_ Art 495 20 = 1,3% _ Art 495 26 = 1% _ Art 495 32 =1,4%.

Chemical and physical features

The inner layer degree of reticulation of the control test carried out on the samples accordingly to rule UNI EN 579 Art 495 16 = 66,4% _ Art 495 20 = 65,8% _ Art 495 26 = 65,7% _ Art 495 32 = 65,6%.

The outer layer degree of reticulation of the control test carried out on the samples accordingly to rule UNI EN 579 Art 495 16 =1,5%_ Art 495 20 = 1,3% _ Art 495 26 = 1% _ Art 495 32 =1,4%.

Secondo quanto previsto da UNI 10954 1 prospetto 5:

- 1) il materiale utilizzato per lo strato interno è PE-Xb mentre per lo strato esterno è HDPE
- 2) lo strato intermedio del tubo multistrato è in alluminio tipo A punto 5,3 norma UNI 10954 / 1
- 3) nessun scollamento si è verificato dopo la prova di Curvatura
- 4) gli strati non si sono separati dopo la prova di svasamento
- 5) l'aderenza degli strati di materiale plastico allo strato intermedio determinata mediante la separazione degli stessi ha dato il seguente esito:

Accordingly to what scheduled from UNI 10954 1 prospectus 5:

- 1) the material used for the internal layer is PE-Xb while the external layer is in HDPE
- 2) the intermediate layer of the multilayer tube is in aluminium, type A, point 5,3 rule UNI 10954 / 1
- 3) no breakaway has happened after the Bending test
- 4) the layers did not separate after the Countersinking Test
- 5) the bonding of the plastic material to the intermediate layer determined through the separation of the same, gave the following result:

N° prove - N° tests	Dimensioni - Dimension mm	Aderenza - Bonding N/cm
1	10.0	70.3
2	10.0	54.0
3	10.0	46.2
4	10.0	41.1
5	10.0	48.7
Media di 5 provini - Average of 5 tests	10.0	52.1

Il tubo multistrato Art 495 R, dove R sta per ricoperto, si differenzia dal tubo multistrato solo dalla copertura che viene ottenuta utilizzando polietilene espanso a cellule chiuse (tipo spugna). La pellicola che ricopre la spugna è fatta sempre in polietilene. La ricopertura segue la normativa L 10/91 secondo la normativa antincendio CL 1. La guaina è di colore rosso cardinale mentre la spugna ha uno spessore di 6 mm equamente arrotolato intorno al tubo è di colore grigio. Sulla guaina sono riportate una serie di informazioni: data di confezionamento, misura del tubo, materia prima utilizzata, normative metratura per facilitarne l'utilizzo.

The multilayer tube Art. 495 R (R stands for covered) is different from the multilayer tube only for the cover obtained by using closed cells expanded polyethylene (sponge type). The tape covering the sponge is also made by polyethylene. The covering follows the regulation L 10/91 in accordance with the fire regulation CL 1. The cover is red colour while the sponge has a mm. 6 thickness equally wrapped around the tube and is grey colour. Some info are printed on the covering: packing date, tube length, raw material, measurement regulation to help the use.

SERIE 490 | 490 SERIE

Raccordi in ottone per tubo polietilene
Fittings for polyethylene pipe

Ogiva in metallo.
Metal ogive.



490RM
Raccordo diretto maschio.
Straight male coupler.

Art.	Dimensione/Size	€
490RM1220	1/2x20 mm	€ 4,50
490RM3425	3/4x25 mm	€ 6,30
490RM1032	1"x32 mm	€ 10,30
490RM11440	1"1/4x40 mm	€ 14,60
490RM11250	1"1/2x50 mm	€ 19,30
490RM2063	2"x63 mm	€ 38,70



490RF
Raccordo diretto femmina.
Straight female coupler.

Art.	Dimensione/Size	€
490RF1220	1/2x20 mm	€ 4,70
490RF3425	3/4x25 mm	€ 6,50
490RF1032	1"x32 mm	€ 11,20
490RF11440	1"1/4x40 mm	€ 14,20
490RF11250	1"1/2x50 mm	€ 24,40
490RF2063	2"x63 mm	€ 37,00



490RD
Manicotto di accoppiamento.
Connecting coupler.

Art.	Dimensione/Size	€
490RD2020	20x20 mm	€ 7,40
490RD2525	25x25 mm	€ 10,00
490RD3232	32x32 mm	€ 15,90
490RD4040	40x40 mm	€ 28,90
490RD5050	50x50 mm	€ 30,20



490GD
Raccordo a gomito bigiunto.
Connecting elbow.

Art.	Dimensione/Size	€
490GD2020	20x20 mm	€ 6,60
490GD2525	25x25 mm	€ 11,60



490GF
Raccordo a gomito femmina.
Female elbow.

Art.	Dimensione/Size	€
490GF1220	1/2x20 mm	€ 4,40
490GF3425	3/4x25 mm	€ 8,80
490GF1032	1"x32 mm	€ 12,90



490GM
Raccordo a gomito maschio.
Male elbow.

Art.	Dimensione/Size	€
490GM1220	1/2x20 mm	€ 5,00
490GM3425	3/4x25 mm	€ 7,80
490GM1032	1"x32 mm	€ 13,30



490TE
Raccordo a "T".
Equal tee coupler.

Art.	Dimensione/Size	€
490TE202020	20x20x20 mm	€ 10,20
490TE252525	25x25x25 mm	€ 17,00



490TF
Raccordo a "T" femmina.
Female tee coupler.

Art.	Dimensione/Size	€
490TF201220	20x1/2x20 mm	€ 8,50
490TF253425	25x3/4x25 mm	€ 10,30



490TM
Raccordo a "T" maschio.
Male tee coupler.

Art.	Dimensione/Size	€
490TM201220	20x1/2x20 mm	€ 7,60
490TM253425	25x3/4x25 mm	€ 9,80

ACCESSORI PER RADIATORI - RADIATOR ACCESSORIES



540DX
540SX

Tappe zincate per radiatori in ghisa e acciaio, destro e sinistro, tappo cieco.
Zinc plated plug for radiators in cast iron and stainless steel, right and left, no hole plug.

	1"	1"x1/4"	1"x3/8"	1"x1/2"	1"1/4"	1"1/4x1/2"
DX	€ 0,83	€ 0,83	€ 0,83	€ 0,99	€ 2,00	€ 2,20
SX	€ 0,83	€ 0,83	€ 0,83	€ 0,99	€ 2,00	€ 2,20



541DX
541SX

Tappe verniciate per radiatori in alluminio, destro e sinistro, tappo cieco.
Plug for radiators in aluminium, painted white, right and left, no hole plug.

	1"	1"x1/4"	1"x3/8"	1"x1/2"	1"x3/4"	1"1/4"
DX	€ 1,30	€ 0,96	€ 0,96	€ 1,90	€ 1,30	€ 2,20
SX	€ 1,30	€ 0,96	€ 0,96	€ 1,90	€ 1,30	€ 2,20



430

Valvolina sfogo aria manuale, per radiatori, con guarnizione in P.T.F.E. cromata.
C.P. drain plug for radiators with P.T.F.E. seal ring.

	1/4"	3/8"	1/2"
	€ 0,94	€ 1,40	€ 1,60



431

Valvolina sfogo aria manuale, per radiatori, cromata a scarico orientabile.
C.P. drain plug for radiators, adjustable.

	3/8"	1/2"
	€ 0,94	€ 0,99



431TA

Tappe in ottone cromato per radiatori.
C.P. brass plug for radiators.

	3/8"	1/2"
	€ 0,82	€ 0,89



544

Chiave in plastica dura, per tappi verniciati.
Key for art. 541, in strong plastic.

€ 5,50



545 1" x 1/2" € 7,20

54538 1" x 3/8" € 7,20

Kit per radiatori in alluminio, composto da: 2 riduzioni destre e 2 sinistre, tutte verniciate, da 1" x 3/8 o 1" x 1/2, 1 tappo cieco in ottone con o-ring da 3/8 o 1/2, 4 guarnizioni esente amianto, spessore 1,5 mm e Ø 42 mm, 1 valvola di sfogo aria da 3/8 o 1/2, il tutto in skinpack Remer.

Kit for aluminum radiators, composed by: 2 right and 2 left reductions, all painted, size 1" x 3/8 or 1" x 1/2, 1 no hole plug in brass with 3/8 or 1/2 oring, 4 asbestos free washers thickness 1,5 mm and Ø 42 mm, 1 drain plug in 3/8 or 1/2 size, all packed in a Remer skinpack.



546 1" x 1/2" € 7,00

54638 1" x 3/8" € 7,00

Kit per radiatori in ghisa, composto da: 2 riduzioni destre e 2 sinistre, zincate, disponibili da: 1" x 3/8, 1" x 1/2, 1"1/4 x 3/8, 1"1/4 x 1/2, 1 tappo cieco in ottone con o-ring da 3/8 o 1/2, 4 guarnizioni esente amianto, spessore 1,5 mm e Ø 42, 1 valvola di sfogo aria da 3/8 o 1/2, il tutto in skinpack Remer.
Kit for iron radiators, composed by: 2 right and 2 left reductions, all painted, available is sizes: 1" x 3/8, 1" x 1/2, 1"1/4 x 3/8, 1"1/4 x 1/2, 1 no hole plug in brass with 3/8 or 1/2 oring, 4 asbestos free washers thickness 1,5 mm and Ø 42 mm, 1 drain plug in 3/8 or 1/2 size, all packed in a Remer skinpack.



548 1" x 1/2" € 10,10

54838 1" x 3/8" € 10,10

Kit per radiatori in alluminio, composto da: 2 riduzioni destre e 2 sinistre, tutte verniciate, da 1" x 3/8 o 1" x 1/2, 1 tappo cieco in ottone con o-ring da 3/8 o 1/2, 4 guarnizioni esente amianto, spessore 1,5 mm e Ø 42, 1 valvola di sfogo aria da 3/8 o 1/2, coppia mensole piatte complete con tassello Ø mm 12, lunghezza mm 170, il tutto in skinpack Remer.
Kit for aluminum radiators, composed by: 2 right and 2 left reductions, all painted, size 1" x 3/8 or 1" x 1/2, 1 no hole plug in brass with 3/8 or 1/2 oring, 4 asbestos free washers thickness 1,5 mm and Ø 42 mm, 1 drain plug in 3/8 or 1/2 size, two painted and flat anchor brackets, with nut Ø mm 12, length mm 170, all packed in a Remer skinpack.

FLESSIBILI
FLEXIBLE HOSES

MINUTERIA
MINUTERY

VALVOLE
VALVES

RACCORDERIA
FITTINGS

ACCESSORI
ACCESSORIES

COMPONENTI PLASTICI
PLASTIC COMPONENTS

RACCORDERIA - FITTINGS



621

Collare fermatubo con tassello, in nylon, con vite in ferro zincato, conf 100 pz.
Collars for pipes clamping with nylon nut and zinc iron screws, in packing of 100 pcs.

Ø	10 mm	12 mm	14 mm	16 mm	18 mm	20 mm	22 mm	24 mm	26 mm	28 mm
€	0,20	0,22	0,33	0,35	0,54	0,56	0,63	0,88	0,93	0,95



622

Collare doppio fermatubo con tassello, in nylon, con vite in ferro zincato, conf. 100 pz.
Double collars for pipes clamping with nylon nut and zinc iron screws, in packing of 100 pcs.

Ø	10 mm	12 mm	14 mm	16 mm	18 mm	20 mm	22 mm	24 mm	26 mm	28 mm
€	0,48	0,50	0,52	0,56	0,75	0,80	0,82	1,05	1,05	1,20



630205

€ 3,50

Coppia mensole Ø 12 per radiatori in ghisa e acciaio a 4/5 colonne, con tasselli, lunghezza mm 205.
Two galvanised anchor brackets Ø 12 for holding radiators in iron and steel with 4/5 columns, with nuts, length mm 205.



632170

€ 2,20

Coppia mensole zincate Ø 7, per radiatori in alluminio, con tasselli, lunghezza mm 170.
Two galvanised anchor brackets Ø 7 for holding radiators in aluminium, with nuts, length mm 170

630B1205

€ 4,10

Coppia mensole verniciate bianche Ø 12 per radiatori in ghisa e acciaio a 4/5 colonne, con tasselli, lunghezza mm 205.
Two galvanised anchor brackets painted white Ø 12 for holding radiators in iron and steel with 4/5 columns, with nuts, length mm 205.

632B1170

€ 2,00

Coppia mensole bianche verniciate Ø 7, per radiatori in alluminio, con tasselli, lunghezza mm 170.
Two galvanised anchor brackets Ø 7 painted white for holding radiators in aluminium, with nuts, length mm 170.

632PL170

€ 2,10

Coppia mensole bianche plastificate Ø 7 per radiatori in alluminio, con tasselli, lunghezza mm 170.
Two galvanised anchor brackets Ø 7 white and plastified for holding radiators in aluminium, with nuts, length mm 170.



633

€ 2,20

Coppia mensole Ø 7 bianche verniciate e di forma piatta, per radiatori in alluminio, con tasselli, lunghezza mm 170.
Two galvanised anchor brackets Ø 7 flat shaped and painted white for holding radiators in aluminium, with nuts, length mm 170.

633PL170

€ 2,20

Coppia mensole Ø 7 bianche plastificate, verniciate e di forma piatta, per radiatori in alluminio, con tasselli, lunghezza mm 170.
Two galvanised anchor brackets Ø 7 plastified, flat shaped and painted white for holding radiators in aluminium, with nuts, length mm 170.



63522

Ø mm 220

€ 0,82

63526

Ø mm 260

€ 0,91

Mensola zincata per radiatori in ghisa e acciaio spessore 15/10, lunghezza mm 220 e 260.
Wall bracket for holding radiators in iron and steel, thickness 15/10, length mm 220 e 260.

ACCESSORI PER TUBI - ACCESSORIES FOR PIPES



642

Collari pesanti zincati con dado saldato e tassello, per tubazioni.
Wall collars in galvanized steel welded and plastic nut, for pipes.

3/8	1/2	3/4	1"	1"1/4	1"1/2	2"	2"1/2	3"	4"
€ 0,63	€ 0,71	€ 0,73	€ 0,86	€ 0,91	€ 0,94	€ 1,05	€ 1,15	€ 1,45	€ 1,80



643

Collari pesanti in acciaio zincato con dado saldato, con gomma EPDM isolante e tassello, per tubazioni.
Wall collars in galvanized steel welded, with insulating EPDM rubber, with plastic nut, for pipes.

3/8	1/2	3/4	1"	1"1/4	1"1/2	2"	2"1/2	3"	4"
€ 0,88	€ 1,05	€ 1,10	€ 1,20	€ 1,30	€ 1,40	€ 1,75	€ 2,20	€ 2,50	€ 2,80



640

Sgombratubi in filo d'acciaio a spirale Ø mm. 8.
Drain cleaner in 8 mm Ø stainless steel spiral.

	LUNGHEZZA - LENGHT								
Ø 8 mm	150 cm	250 cm	350 cm	500 cm	700 cm	1000 cm	1250 cm	1500 cm	
	€ 3,70	€ 5,40	€ 6,60	€ 9,00	€ 11,90	€ 16,40	€ 17,90	€ 22,90	



645

Fascetta stringitubo in acciaio.
Steel hose clip.

Ø	10/18	14/24	17/29	25/37	25/45	33/53	40/60	48/68	63/83	78/98
	€ 0,74	€ 0,74	€ 0,76	€ 0,88	€ 0,88	€ 0,94	€ 0,97	€ 0,99	€ 1,10	€ 1,20

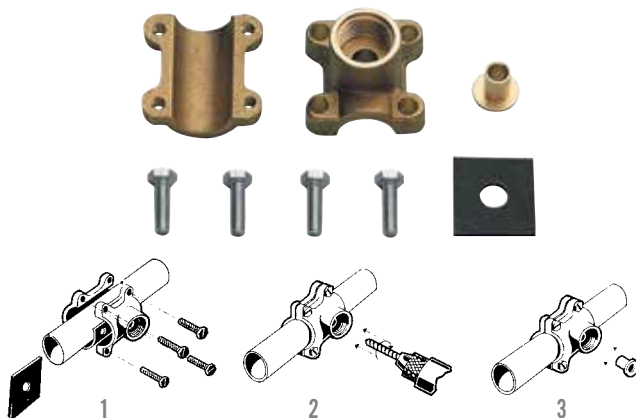

644

Presca rapida per tubi, misure da 1/2" a 2".
Fast punch for water outlet, size from 1/2" to 2".

	Ø A	Ø B	G"
Tubo Pipe	Foro per Acqua Water Hole	Diametro Punta Drill Diameter	Filetto Thread
1/2	7,5 mm	Ø 10 mm	1/2
3/4	10,5 mm	Ø 13,5 mm	1/2
1"	13 mm	Ø 16 mm	3/4
1"1/4	14 mm	Ø 17,5 mm	3/4
1"1/2	14 mm	Ø 17,5 mm	3/4
2"	30 mm	Ø 35 mm	1"1/2

1/2x45	3/4x45	1"x45	1"1/4x71	1"1/2x77	2"x90
€ 8,20	€ 10,50	€ 18,60	€ 21,10	€ 23,40	€ 41,50

FLESSIBILI
FLEXIBLE HOSES

MINUTERIA
MINUTERY

VALVOLE
VALVES

RACCORDERIA
FITTINGS

ACCESSORI
ACCESSORIES

COMPONENTI PLASTICI
PLASTIC COMPONENTS



ACCESSORI ACCESSORIES



FLESSIBILI
FLEXIBLE HOSES

MINUTERIA
MINUTERY

VALVOLE
VALVES

RACCORDERIA
FITTINGS

ACCESSORI
ACCESSORIES

COMPONENTI PLASTICI
PLASTIC COMPONENTS



61



€ 32,50

Rubinetto prolungato con comando a gomito, 1/2.
Wall mounted long tap, 1/2, with long lever.

63



€ 36,10

Rubinetto a snodo con comando a gomito, 1/2, con canna inferiore.
Wall mounted hose-holder tap, 1/2, with long lever and S inferior spout.

64



€ 68,10

Gruppo lavello con comando a gomito e canna inferiore.
Wall mounted mixer, with long levers and S inferior spout.

14LL



€ 80,60

Gruppo lavello tipo a ponte con comando a gomito e canna Ø 18 mm.
Sink mixer bridge type, with long lever and spout Ø 18 mm.

65



€ 42,20

Rubinetto collo cigno con comando a gomito, 1/2.
Wash basin pillar tap, 1/2, with long lever.

61LE



€ 11,40

Leva in ottone cromato per articoli 61, 63, 64, 65, 14LL.
Lever for art. 61, 63, 64, 65, 14LL.

MA14



€ 23,10

Leva lunga per miscelatori con cartuccia Ø 40.
Spare long lever for single lever mixers with Ø 40 cartridge.

61VI



€ 5,40

Vitone da 1/2 per articoli 61, 63, 64, 65, 14LL.
Head valve 1/2 for articles 61, 63, 64, 65, 14LL.

66



€ 128,90

Rubinetto a pedale ad incasso in ottone cromato.
Built in tap foot operated, in c.p. brass.

66MP



€ 137,20

Rubinetto-miscelatore pedaliera universale. Può essere installato sia a parete che a pavimento.
Treadle mixer with universal pedal control. It can be installed both on the wall and on the floor.

67



€ 46,40

Bocca a snodo per lavello.
Movable spout for washbasin.

67N



€ 65,40

Bocca alta minimale.
Minimal high spout.

67Q



€ 95,30

Bocca alta quadrata.
Squared high spout.

69



€ 60,40

Rubinetto a pulsante a zampillo parabolico per refrigeratore o depuratore. Regolazione del getto sotto il pulsante.
Parabolic jet button tap for refrigerator or purifier. Water flow control under the button.

CARTUCCE - CARTRIDGES



P50

€ 24,60

Cartuccia progressiva Ø 35, con distributori, con chiusura del flusso e uscita dell'acqua verso il basso.
Ceramic cartridge Ø 35, with distributors, with flow shut-off and water outlet towards the low.



P52

€ 24,60

Cartuccia progressiva Ø 35, senza distributori, con chiusura del flusso e uscita dell'acqua verso il basso.
Ceramic cartridge Ø 35, without distributors, with flow shut-off and water outlet towards the low.



V50C

€ 22,50

Cartuccia a dischi ceramici Ø 25 mm, tipo piatto.
Ceramic cartridge Ø 25 mm, flat bottom type



V50A

€ 22,50

Cartuccia a dischi ceramici Ø 25, con uscita dell'acqua direttamente dalla parte alta dell'involucro a cilindro senza quindi essere riconvolgato verso il fondo della cartuccia.
Ceramic discs cartridge Ø 25, with water outlet directly from the top part of the cylindrical shell without being joined towards the bottom of the cartridge.



J50 € 20,50
 Cartuccia a dischi ceramici Ø mm 35, movimento a "joystick", tipo piatto.
 Ceramic cartridge Ø 35 mm, "joystick" movement, flat bottom type



E50C € 92,60
 Cartuccia termostatica coassiale serie MINIMAL THERMO e QUBIKA THERMO.
 Thermostatic coaxial cartridge serie MINIMAL THERMO and QUBIKA THERMO.



E50P € 40,70
 Cartuccia termostatica con rotazione manopola a 330° angolari, blocco di sicurezza a 38°C, campo di lavoro da 5°C a 80°C, campo di pressione da 1 a 10 bar, filtro inox e sistema di sicurezza con blocco dell'erogazione in caso di mancanza di una delle due acque, realizzato con materiali termoplastici ad elevata robustezza.
 Thermostatic cartridge with 330° angular handle rotation, 38° safety lock, working field from 5°C to 80°C, pressure field from 1 to 10 bar, stainless steel filter and safety system with the outlet lock in case there is one water lock, high performance thermoplastic materials.



CLICK SYSTEM

S50AF € 12,00
 Cartuccia ad apertura forzata Ø mm 40 a dischi ceramici per vasca, lavabo, bidet (tipo con distributori) permette un notevole risparmio idrico.
 Forced opening ceramic cartridge Ø 40 mm for bath, wash basin, bidet (type with distributors) permit a remarkable saving of water.



CLICK SYSTEM

S52AF € 12,00
 Cartuccia ad apertura forzata Ø mm 40 a dischi ceramici per lavello, doccia (tipo piatto) permette un notevole risparmio idrico.
 Forced opening ceramic cartridge Ø 40 mm for sink, shower (flat bottom type) permit a remarkable saving of water.



CLICK SYSTEM

R52AF € 12,00
 Cartuccia ad apertura forzata Ø 35 mm a dischi ceramici per lavello, doccia (tipo piatto) permette un notevole risparmio idrico.
 Forced opening ceramic cartridge Ø 35 mm for sink, shower (flat bottom type) permit a remarkable saving of water.



CLICK SYSTEM

R50AF € 12,00
 Cartuccia ad apertura forzata Ø 35 mm a dischi ceramici per vasca, lavabo, bidet (tipo con distributori) permette un notevole risparmio idrico.
 Forced opening ceramic cartridge Ø 35 mm for bath, wash basin, bidet (type with distributors) permit a remarkable saving of water.

CARTUCCE IN BLISTER - CARTRIDGES IN BLISTER



S50Y € 9,90
 Cartuccia Ø mm 40 a dischi in ceramica per vasca, lavabo, bidet (tipo con distributori).
 Ceramic cartridge Ø 40 mm for bath, wash basin, bidet (type with distributor).



S52Y € 9,90
 Cartuccia Ø mm 40 a dischi in ceramica per lavello, doccia (tipo piatto).
 Ceramic cartridge Ø 40 mm for sink and shower (flat bottom type).



R50Y € 9,90
 Cartuccia Ø mm 35 a dischi in ceramica per vasca, lavabo, bidet (tipo con distributori).
 Ceramic cartridge Ø 35 mm for bath, wash basin, bidet (type with distributor).



R52Y € 9,90
 Cartuccia Ø mm 35 a dischi in ceramica per lavello, doccia (tipo piatto).
 Ceramic cartridge Ø 35 mm for sink and shower (flat bottom type).



W50Y € 20,50
 Cartuccia Ø mm 35 a dischi ceramica per lavello, doccia, vasca, bidet (tipo piatto).
 Ceramic cartridge Ø 35 mm for sink, shower, bath, bidet (flat bottom type).

FLESSIBILI
FLEXIBLE HOSES

MINUTERIA
MINUTERY

VALVOLE
VALVES

RACCORDERIA
FITTINGS

ACCESSORI
ACCESSORIES

COMPONENTI PLASTICI
PLASTIC COMPONENTS

DEVIATORI - DIVERTERS



Q93DEV3

Deviatore a tre vie (una entrata e tre uscite) su piastra, serie Qubika.
Three ways diverter (1 inlet and 3 outlets) on flange, Qubika serie.

CR € 243,40



Q93DEV7

Deviatore a tre vie e sette posizioni (una entrata, tre uscite e sette posizioni con cui selezionare uscite singole o miscelate tra loro) su piastra, serie Qubika.
Three ways diverter with seven positions (1 inlet and 3 outlets and seven positions to select single or mixed outlets) on flange, Qubika serie.

CR € 243,40



N93DEV3

Deviatore a tre vie (una entrata e tre uscite) su piastra, serie Minimal.
Three ways diverter (1 inlet and 3 outlets) on flange, Minimal serie.

CR € 213,20



N93DEV7

Deviatore a tre vie e sette posizioni (una entrata, tre uscite e sette posizioni con cui selezionare uscite singole o miscelate tra loro) su piastra, serie Minimal.
Three ways diverter with seven positions (1 inlet and 3 outlets and seven positions to select single or mixed outlets) on flange, Minimal serie.

CR € 213,20

PROLUNGHE - EXTENSIONS



K09PROL

€ 63,00

Prolunga per corpo monocomando doccia incasso con deviatore per cartuccia Ø 40 mm.
Extension for built-in shower mixer body with diverter for cartridge Ø 40 mm.



N09PROL

€ 63,00

Prolunga per corpo monocomando doccia incasso con deviatore per cartuccia Ø 35 mm.
Extension for built-in shower mixer body with diverter for cartridge Ø 35 mm.



S52PROL

€ 26,90

Prolunga per corpo monocomando doccia incasso con cartuccia Ø 40 mm.
Extension for built-in shower mixer body with cartridge Ø 40 mm.



R52PROL

€ 26,90

Prolunga per corpo monocomando doccia incasso con cartuccia Ø 35 mm.
Extension for built-in shower mixer body with cartridge Ø 35 mm.

DEVIATORI AUTOMATICI - AUTOMATIC DIVERTERS



78

€ 0,16

Vite fissa maniglia.
Screw for fixing handle.



80SN

€ 1,10

Morsetto con vite per scarico automatico.
Joint with screw for pop-up waste.



DEV00

€ 9,10

Deviatore in ottone automatico con molla e fermo per basse pressioni.
Automatic brass diverter with spring and lock for low pressure.



DEV08

€ 11,10

Deviatore in ottone automatico con molla e fermo, con prolunga 8 mm.
Automatic brass diverter with spring and lock, mm 8 extended in 1/2 side.



DEV13

€ 12,80

Deviatore in ottone automatico con molla e fermo, con prolunga 13 mm.
Automatic brass diverter with spring and lock, mm 13 extended in 1/2 side.

VITONE - HEADVALVES



75 € 22,20
 Vitone universale per rubinetti, che permette di ottenere 102 combinazioni di misure e lunghezze. Confezione skin-pack.
 Universal headvalve for taps, allow to create 102 different combinations of lengths and sizes. Packed in a safe skin-pack.



7719 € 4,50
 Vitone con filetto 19/19, per rubinetti incasso.
 19/19 Head valve thread, for built-in stop cocks.



74 € 3,60
 Vitone da 1/2 per gruppo vasca, lavello, batteria lavabo, rubinetto bidet e incasso per art. 53, 55.
 Head valve 1/2" for bath, sink, wash basin, bidet and built-in stop cock for art. 53, 55.



74E € 2,80
 Come 74, tipo leggero.
 As 74, light type.



74F € 3,80
 Vitone da 1/2 con filetto per coprivitone M24x1.
 Head valve 1/2 with thread M24x1 for head valve cover.



7718 € 2,80
 Vitone filetto 18/19 per art. 221, 223, 224, 250, 252 e altri.
 18/19 Head valve thread for art. 221, 223, 224, 250, 252 and others.



7738 € 2,80
 Vitone con filetto 3/8, per rubinetti.
 3/8 Head valve thread, for taps.



76DX180 € 8,00
 Vitone 180° a dischi ceramici, broccia Ø mm 8, 20 denti, destro.
 Head valve 180° ceramic discs, broach Ø 8 mm, 20 teeth, right.



76DX24 € 8,00
 Vitone 90° a dischi ceramici, broccia Ø 8 mm, 24 denti, destro.
 Head valve 90° ceramic discs, broach Ø 8 mm, 24 teeth, right.



76DX € 8,00
 Vitone 90° a dischi ceramici, broccia Ø 8 mm, 20 denti, destro.
 Head valve 90° ceramic discs, broach Ø 8 mm, 20 teeth, right.



76SX180 € 8,00
 Vitone 180° a dischi ceramici, broccia Ø mm 8, 20 denti, sinistro.
 Head valve 180° ceramic discs, broach Ø 8 mm, 20 teeth, left.



76SX24 € 8,00
 Vitone 90° a dischi ceramici, broccia Ø 8 mm, 24 denti, sinistro.
 Head valve 90° ceramic discs, broach Ø 8 mm, 24 teeth, left.



76SX € 8,00
 Vitone 90° a dischi ceramici, broccia Ø 8 mm, 20 denti, sinistro.
 Head valve 90° ceramic discs, broach Ø 8 mm, 20 teeth, left.

FLESSIBILI
FLEXIBLE HOSES

MINUTERIA
MINUTERY

VALVOLE
VALVES

RACCORDERIA
FITTINGS

ACCESSORI
ACCESSORIES

COMPONENTI PLASTICI
PLASTIC COMPONENTS



AERATORI: LINEA RISPARMIO IDRICO-ENERGICO E ANTIVANDALICO
AERATOR: WATER ENERGY SAVING LINE AND ANTI-VANDALISM



83AVC € 4,20

Kit antivandalico e anticalcare composto da aeratore speciale per miscelatori lavabo e bidet M24 e chiave di montaggio, manutenzione e pulizia settimanale, ad alta tecnologia, brevettata. Anti-vandalism and anti-limestone kit, composed by special aerator for wash basin and bidet mixers M24 and assembly, caring and weekly cleaning key, high technology and patented.



83SETL6 - 83SETL8

Set risparmio idrico totale composto da raccordo doccia 1/2" in ottone cromato a portata limitata, aeratore lavabo e bidet M24 a portata limitata e chiave di montaggio manutenzione e pulizia settimanale, ad alta tecnologia, brevettata. Il kit e' disponibile in varianti da 6 litri al minuto (cod 83 SET L6) o 8 litri al minuto (cod 83 SET L8).

Total water saving set, composed by 1/2" shower connection with reduced flow in c.p. brass, wash basin and bidet aerator with reduced flow and assembling, caring and weekly cleaning key, high technology, patented. This set is available with outlet flow of 6 liters by minute (cod 83 SET L6) or 8 liters by minute (cod 83 SET L8).



83AVCL6 - 83AVCL8

Kit come 83 AVC, più risparmio idrico, che include anche limitatore di portata da 6 litri al minuto, art 83AVC L6, o limitatore di portata da 8 litri al minuto, art 83 AVC L8.

Kit same as 83 AVC, plus water saving, that also includes one reduction of water consumption at 6 liters by minute, art 83 AVC L6, or one reduction of water consumption at 8 liters by minute, art 83 AVC L8.

83AVCL6
€ 6,10

83AVCL8
€ 6,10



83L6 - 83L8

Aeratore lavabo e bidet M24, per risparmio idrico con limitatore di portata da 6 litri al minuto (art. 83 L6) o da 8 litri al minuto (art. 83 L8).

Aerator for wash basin and bidet mixers, M24, water saving, with reduction of consumption and excellent flow at 6 litres by minute (art. 83 L6) or 8 liters by minute (art. 83 L8).

83L6
€ 3,50

83L8
€ 3,50

83SETL6
€ 12,30

83SETL8
€ 12,30



662FI12

Guarnizione da 1/2" con filtro retinato anti-impurità. 1/2" washer with net filter, anti-impurity.

€ 0,32



662RE12

Guarnizione da 1/2" a passaggio ridotto, con risparmio idrico del 30%. 1/2" washer, reduced flow, water saving 30%.

€ 0,24



309RL6 - 309RL8

Raccordo doccia 1/2" a risparmio idrico con limitatore di portata da 6 litri al minuto (art 309 L6) o 8 litri al minuto (art 309 L8).

C.p. brass connection, water saving program with flow reduction at 6 liters by minute (art 309 L6) or 8 liters by minute (art 309 L8).

309RL6
€ 4,90

309RL8
€ 4,90



KIT PULIZIA AERATORE
CLEANING KIT WITH AERATOR



83SET01

€ 8,70

Set completo di 3 aeratori anticalcare M24 ad alta tecnologia + 1 chiave per la pulizia settimanale, brevettati e di lunghissima durata, il tutto in ottone cromato e materiale plastico innovativo a forte resistenza, confezionato in un tubo contenitore rigido e trasparente adatto per essere appeso. La chiave è stata studiata per pulire il calcare dall'aeratore in un solo semplice movimento.

Set complete of 3 anti-limestone M24 aerators of high technology + 1 weekly cleaning key, patented and extremely long lasting, all in c.p. brass and innovative plastic material very resistant, packed in a holding hard and transparent tube, suitable to be hung. The key has been studied to clean the aerator in one simple, easy movement.



83SET02

€ 8,70

Set completo di 2 aeratori anticalcare M24 ad alta tecnologia ed e 1 aeratore anticalcare F22 + 1 chiave per la pulizia settimanale, brevettati e di lunghissima durata, il tutto in ottone cromato e materiale plastico innovativo a forte resistenza, confezionato in un tubo contenitore rigido e trasparente adatto per essere appeso. La chiave è stata studiata per pulire il calcare dall'aeratore in un solo semplice movimento.

Set complete of 2 anti-limestone M24 aerators of high technology and 1 anti-limestone F22 aerator + 1 weekly cleaning key, patented and extremely long lasting, all in c.p. brass and innovative plastic material very resistant, packed in a holding hard and transparent tube, suitable to be hung. The key has been studied to clean the aerator in one simple, easy movement.



81AC € 3,10

Set completo di 1 aeratore F22 anticalcare ad alta tecnologia + 1 chiave di pulizia settimanale, brevettati e di lunghissima durata, il tutto in ottone cromato e materiale plastico innovativo a forte resistenza. L'aeratore e la chiave sono stati studiati per pulire il calcare dall'aeratore in un solo semplice movimento.
Set complete of 1 anti-limestone F22 aerator of high technology + 1 weekly cleaning key, Patented and extremely long lasting, all in c.p. brass and innovative plastic material very resistant. The aerator and the key has been studied to clean the aerator in one simple, easy movement.



83AC € 3,10

Set completo di 1 aeratore M24 anticalcare ad alta tecnologia + 1 chiave di pulizia settimanale, brevettati e di lunghissima durata, il tutto in ottone cromato e materiale plastico innovativo a forte resistenza. L'aeratore e la chiave sono stati studiati per pulire il calcare dall'aeratore in un solo semplice movimento.
Set complete of 1 anti-limestone M24 aerator of high technology + 1 weekly cleaning key, Patented and extremely long lasting, all in c.p. brass and innovative plastic material very resistant. The aerator and the key has been studied to clean the aerator in one simple, easy movement.

RIDUZIONI - REDUCTION



81RD12 € 4,70

Riduzione 1/2MxM22. Consente di collegare qualsiasi attacco da 1/2F", esempio tutti i flessibili doccia, con un aeratore standard lavabo/lavello F22, vedi ns articolo 81A (al posto di una doccetta o di uno shut off).
Reduction 1/2MxM22. Allows to connect any 1/2F" connection, for example all the shower flexibles, with a standard aerator basin/sink F22, see our art. 81A (instead of the classic handshower or shut-off).



81RD12M22F € 4,70

Riduzione 1/2MxF22. Consente di collegare al lavabo/lavello F22 un qualsiasi componente con attacco 1/2F.
1/2MxF22 reduction. Connecting any component with 1/2F connection to the washbasin/sink F22.



83RD12F22F € 4,70

Riduzione 1/2FxM22. Consente di collegare al lavabo/lavello F22 un qualsiasi componente con attacco 1/2M.
1/2FxM22 reduction. Connecting any component with 1/2M connection to the washbasin/sink F22.



83RD12 € 4,70

Riduzione 1/2MxF24. Consente di collegare qualsiasi attacco da 1/2F", esempio tutti i flessibili doccia, con un aeratore standard lavabo M24, vedi ns articolo 83A (al posto di una doccetta o di uno shut off).
Reduction 1/2MxF24. Allows to connect any 1/2F" connection, for example all the shower flexibles, with a standard aerator basin M24, see our art. 83A (instead of the classic handshower or shut-off).



83RD12M24M € 4,70

Riduzione 1/2MxM24. Consente di collegare al lavabo/lavello M24 un qualsiasi componente con attacco 1/2F.
1/2MxM24 reduction. Connecting any component with 1/2F connection to the washbasin/sink M24.



83RD12F24M € 4,70

Riduzione 1/2FxM24. Consente di collegare al lavabo/lavello M24 un qualsiasi componente con attacco 1/2M.
1/2FxM24 reduction. Connecting any component with 1/2M connection to the washbasin/sink M24.



82 € 2,40

Aeroflux a due getti, con doccetta a snodo, filetto F22 con riduzione M24.
Double spray aerator, with balljoint shower, thread F22 with reduction M24.



82DJ € 44,10

Aeroflux "Dual Jet" in ottone cromato a due getti, con doccetta a snodo e filetto F22.
Double spray c.p. brass shower-aerator "Dual Jet", with ball-joint shower, thread F22.



82UN € 1,60

Aeroflux a due getti, con doccetta a snodo, con attacco universale.
Double spray aerator, with balljoint shower, with standard connection.



82L € 1,90

Aeroflux a due getti, con manicotto a vite, lunghezza cm 15.
Double spray aerator, with screw standard connection, length 15 cm.



82LGH € 2,50

Aeroflux a due getti, con ghiera e filetto F22, lunghezza 15 cm.
Double spray aerator, with nut and thread F22, length 15 cm.

FLESSIBILI
FLEXIBLE HOSES

MINUTERIA
MINUTERY

VALVOLE
VALVES

RACCORDERIA
FITTINGS

ACCESSORI
ACCESSORIES

COMPONENTI PLASTICI
PLASTIC COMPONENTS

AERATORI - AERATOR

81A



€ 1,60

Aeratore anticalcare ad alta tecnologia F22, brevettato e di lunghissima durata, scocca in ottone ed interno in materiale plastico innovativo a forte resistenza.
High technology anti-limestone aerator F22, patented and long-lasting, shell in c.p. brass, internal in innovative plastic material very resistant.

83A



€ 1,60

Aeratore anticalcare ad alta tecnologia M24, brevettato e di lunghissima durata, scocca in ottone ed interno in materiale plastico innovativo a forte resistenza.
High technology anti-limestone aerator M24, patented and long-lasting, shell in c.p. brass, internal in innovative plastic material very resistant.

83C



€ 1,90

Chiave brevettata per la pulizia settimanale degli aeratori ad alta tecnologia art 81 A e art 83 A.
Patented key for the weekly cleaning of the high technology aerators art 81 A and 83 A.

81



€ 1,60

Aeratore classico con retine in inox, per gruppo lavello F22.
Classic aerator with inox nets, for sink spout F22.

83



€ 1,60

Aeratore classico con retine in inox, per lavabo, lavello e bidet M24.
Classic aerator with inox nets, for basin, bidet and sink, M24.

84A



€ 2,50

Aeratore per gruppo vasca, M28.
Aerator for bath mixer, M28.

83F16



€ 4,00

Aeratore F16.
F16 aerator.

81SN



€ 2,90

Snodo attacco F22 con ghiera M22.
Joint F22 and nut M22.

83SN



€ 2,90

Snodo attacco M22 con ghiera M24.
Joint M22 and nut M24.

83N41



€ 3,40

Aeratore M18.
M18 aerator.

85



€ 4,50

Aeratore con snodo per monoforo bidet, M24.
Balljoint aerator for one-hole bidet, M24.

83NESI



€ 3,60

Aeratore Neoperl autopulente M24X1 con erogatore in silicone morbido anticalcare per una pulizia manuale semplificata.
Neoperl aerator selfcleaning M24X1 with silicon antilimestone bottom, for soft simplified handcleaning.

83NE



€ 1,90

Aeratore Neoperl effetto a scomparsa, con tecnologia in silicone autopulente per una pulizia veloce dal calcare, con filetto M24X1 che puo' essere sostituito senza difficoltà a tutte le rubinetterie con filettatura per aeratore M24X1. Molto indicato per modelli di design quali Qubika, Minimal, SQ.
Neoperl aerator with built-in effect, with silicon anti-limestone technology for an easier cleaning, M24X1 thread, can be easily substituted to all the standard mixers with M24X1 aerators.
Very indicated for design models like Qubika, Minimal, SQ.

83NEBA



€ 3,80

Aeratore Neoperl M24X1 con getto direzionabile tramite terminale basculante, permette con il semplice tocco della parte inferiore dell'aeratore di dirigere il flusso della direzione desiderata.
Neoperl aerator M24X1 with movable aerator bottom that, with the simple touch, permits to move the flow to the preferred direction.

83EU



€ 1,70

Aeratore Neoperl M24 coin slot. Installazione e rimozione dell'aeratore utilizzando una moneta inserita nell'apposita fessura.
Neoperl aerator M24 coin slot. Installation and removal of the aerator by using a coin placed in the slot.

83Z40



€ 4,10

Aeratore M24 ultrapiatto, utilizzabile su ogni lavabo o lavello. Installazione e rimozione con chiave 83 Z40 C.
Ultra-flat aerator M24, suitable on every wash-basin or sink. Installation and removal with key 83 Z40 C.

83Z40C



€ 1,90

Chiave brevettata per la pulizia settimanale degli aeratori ad alta tecnologia art 83 Z40.
Patented key for the weekly cleaning of the high technology aerators art 83 Z40.

ECCENTRICI E DISTANZIATORI - ECCENTRICS & CONNECTIONS

89 € 2,70
 Eccentrico per gruppi, 1/2 x 3/4, con rosone in ottone cromato.
 Eccentric unions for mixers, 1/2 x 3/4, with C.P. brass flange.



89L € 3,20
 Eccentrico per gruppi, 1/2x3/4, tipo Lusso, con rosone in ottone cromato.
 Eccentric unions for mixers, 1/2 x 3/4, with C.P. brass flange.



89N € 4,80
 Eccentrico per gruppi, 1/2 x 3/4, con rosone minimale in ottone cromato.
 Eccentric unions for mixers, 1/2 x 3/4, with minimal C.P. brass flange.

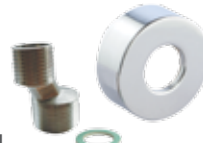

Distanziatore per gruppi, 1/2x3/4, lunghezza cm.4, 6, 8.
 C.P. brass S-connection for mixers, 1/2x3/4, length 4, 6, 8 cm.

9012344	cm 4	€ 13,00
9012346	cm 6	€ 13,80
9012348	cm 8	€ 14,70

FLESSIBILI
FLEXIBLE HOSES

MINUTERIA
MINUTERY

VALVOLE
VALVES

COLONNE PER BORDO VASCA - VERTICAL CONNECTION FOR BATH MIXER

8801LI CR € 327,80
 Coppia colonne vasca in ottone cromato, serie Liberty, 3/4M x 3/4M.
 Couple c.p. brass vertical connections for bath mixer, serie Liberty, 3/4M x 3/4M.



8801LIS CR € 626,90
 Coppia colonne vasca in ottone cromato, serie Liberty, con supporto doccia, 3/4M x 3/4M.
 Couple c.p. brass vertical connections for bath mixer, serie Liberty, with hand shower holder 3/4M x 3/4M.



88N02 CR € 422,50
 Coppia colonne vasca in ottone cromato, serie Minimal, con supporto doccia, 3/4M x 3/4M.
 Couple c.p. brass vertical connections for bath mixer, serie Minimal, with hand shower holder 3/4M x 3/4M.

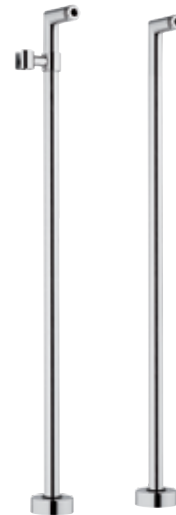

RACCORDERIA
FITTINGS

ACCESSORI
ACCESSORIES

COMPONENTI PLASTICI
PLASTIC COMPONENTS

88UK CR € 56,00
 Coppia colonnette bordo vasca in ottone cromato, serie UK, 3/4Mx3/4M.
 Couple c.p. brass vertical connections for bath mixer, serie Minimal, with hand shower holder 3/4M x 3/4M.



88LI CR € 76,00
 Coppia colonnette bordo vasca in ottone cromato, serie Liberty, 3/4M x 3/4M.
 Couple c.p. brass vertical connections for bath mixer, serie Liberty, 3/4M x 3/4M.



88 CR € 19,80
 Colonneta per bordo vasca in ottone cromato, 1/2M x 3/4M.
 C.P. brass vertical connection for bath mixer, 1/2M x 3/4M.



88BI € 24,70
 Colonneta per bordo vasca, verniciata bianca, 1/2M x 3/4M.
 Vertical connection for bath mixer in white colour, 1/2M x 3/4M.



BOCCHIE - SPOUTS



86 CR € 11,00
Canna lavello inferiore a "S", tipo universale, con aeratore.
Lower "S" sink spout, universal type, with aerator.

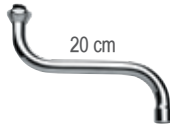

86N CR € 10,00
Canna lavello inferiore a "S", cm 20, con aeratore.
Lower "S" sink spout, cm 20, with aerator.

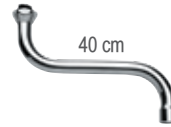

86N40 CR € 15,60
Canna lavello inferiore a "S", cm 40, con aeratore.
Lower "S" sink spout, cm 40, with aerator.

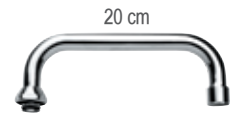

86U CR € 10,00
Canna lavello superiore a "U", cm 20, con aeratore.
Upper "U" sink spout, cm 20, with aerator.



87N CR € 11,90
Canna a "J" per monoforo lavello, con aeratore.
"J" spout for one-hole sink, with aerator.



87 CR € 15,40
Canna a "J" per monoforo lavello, tipo universale, con aeratore.
"J" spout for one-hole sink, universal type, with aerator.



92C CR € 27,50
Canna a biscotto a "C" con calotta da 3/4, con aeratore.
"C" spout with nut 3/4, with aerator.



92CC CR € 23,80
Canna a biscotto a "C" con calotta da 3/4, con aeratore, tipo corto.
"C" spout with nut 3/4, with aerator, short type.



92U CR € 25,80
Canna a "U" Ø 22, con aeratore.
"U" spout Ø 22, with aerator.

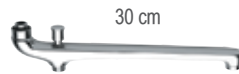

93 CR € 56,50
Canna fusa lunga cm 30 con deviatore, con calotta da 3/4 ed aeratore.
Casted cm 30 long spout with diverter, with 3/4 nut, with aerator.



9216 CR € 17,00
Canna a biscotto diritta, calotta da 3/4, lunghezza cm.16, con aeratore.
Straight spout with 3/4 nut, 16 cm long, with aerator.



9220 CR € 19,10
Canna a biscotto diritta, calotta da 3/4, lunghezza cm.20, con aeratore.
Straight spout with 3/4 nut, 20 cm long, with aerator.



9230 CR € 21,40
Canna a biscotto diritta, calotta da 3/4, lunghezza cm. 30, con aeratore.
Straight spout with 3/4 nut, 30 cm long, with aerator.

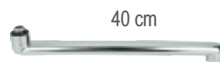

9240 CR € 39,00
Canna a biscotto diritta, calotta da 3/4, lunghezza cm.40, con aeratore.
Straight spout with 3/4 nut, 40 cm long, with aerator.



9250 CR € 42,00
Canna a biscotto diritta, calotta da 3/4, lunghezza cm. 50, con aeratore.
Straight spout with 3/4 nut, 50 cm long, with aerator.

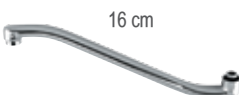

92S16 € 19,20
Canna a biscotto a "S", calotta da 3/4, lunghezza cm.16, con aeratore.
"S" spout with 3/4 nut, 16 cm long, with aerator.

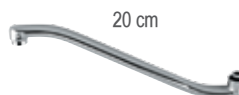

92S20 € 21,60
Canna a biscotto a "S", calotta da 3/4, lunghezza cm.20, con aeratore.
"S" spout with 3/4 nut, 20 cm long, with aerator.

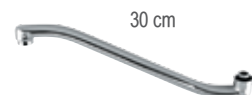

92S30 € 24,30
Canna a biscotto a "S", calotta da 3/4, lunghezza cm.30, con aeratore.
"S" spout with 3/4 nut, 30 cm long, with aerator.

SUPPORTI DOCCIA - SUPPORTS FOR HANDSHOWERS



32507

Supporto per doccia estraibile per bordo lavello e bordo vasca, modello a base tonda.

Support for extensible handshower for deck bath and deck sink, round base model.

CR € 36,60



325S07

Supporto dritto per doccia estraibile per bordo lavello e bordo vasca, modello a base quadrata.

Straight support for extensible handshower for deck bath and deck sink, squared base model.

CR € 33,00

FLESSIBILI
FLEXIBLE HOSES

MINUTERIA
MINUTERY

SCARICHI - WASTES



Tappo scarico automatico in ottone per piletta 1" e per piletta 1"1/4.
C.p. brass plug for pop-up waste for drain 1" and for drain 1"1/4.

95TA10 1" € 4,10

95TA114 1" 1/4 € 5,10



95TAG € 12,80

Tappo grande in ottone cromato per scarico automatico con piletta da 1"1/4.
Big plug in c.p. brass for pop-up waste with drain 1"1/4.



95TAS € 21,00

Tappo grande quadrato in ottone cromato per scarico automatico con piletta da 1"1/4.
Squared big plug in c.p. brass for pop-up waste with drain 1"1/4.



96TA € 4,80

Tappo in ottone cromato per colonna vasca automatica.
Chrome plated brass plug for automatic bath waste and overflow.



BAK10 € 6,60

Basetta in ottone per rubinetteria tipo serie Kiss, Ten, Giga.
Base in c.p. brass for mixers like serie Kiss, Ten, Giga.

VALVOLE
VALVES

RACCORDERIA
FITTINGS

94



€ 4,00

Asta per scarico automatico, lunghezza cm 30, in ottone cromato.
Rod for pop-up waste, length 30 cm, in c.p. brass.

95AC



€ 22,90

Asta e centralina bidet per scarico automatico, in ottone cromato.
Rod and flange for bidet for pop-up automatic waste, in c.p. brass.

95QAC



€ 30,00

Asta e centralina bidet per scarico automatico, in ottone cromato.
Rod and flange for bidet for pop-up automatic waste, in c.p. brass.

AST10



€ 5,10

Asta con pomolo e snodino per serie Ten, in ottone cromato.
Rod with knob and small joint for Ten series, in c.p. brass.

ACCESSORI
ACCESSORIES

COMPONENTI PLASTICI
PLASTIC COMPONENTS

ASK10



€ 4,50

Asta con pomolo e snodino per serie Kiss, in ottone cromato.
Rod with knob and small joint for Kiss series, in c.p. brass.



FISK10 € 2,00

Confezione di fissaggio per art. K10, K20, K40.
Fixing set for art. K10, K20, K40.



FISR10 € 2,70

Confezione di fissaggio per art. R10, R20, R40.
Fixing set for art. R10, R20, R40.



FIST10 € 2,60

Confezione di fissaggio a doppio tirante.
Fixing set with double screw.



FISA10 € 7,60

Confezione di fissaggio per: Atmos, Flash, Qubika Cascata.
Fixing set for: Atmos, Flash, Qubika Waterfall.



FISB10 € 2,70

Confezione di fissaggio per art. S42 U, S10 G, B10, B20, Q42U, Q10 G.
Fixing set for art. S42 U, S10 G, B10, B20, Q42U, Q10 G.

ACCESSORI PER LAVABO - WASH BASIN ACCESSORIES



695 € 4,00
 Copriforo per lavabo, Ø mm 50 in ottone cromato, tipo pesante.
 Tap-hole-cover for wash basin Ø 50 mm in C.P. brass, heavy type.



695BI € 4,60
 Copriforo per lavabo, Ø mm 50 verniciato bianco, tipo pesante.
 Tap-hole-cover for wash basin Ø 50 mm in white color, heavy type.



694 € 1,40
 Copriforo per lavabo Ø mm 44, in acciaio inox.
 Tap-hole-cover for wash basin Ø 44 mm, in stainless steel.



696 € 0,67
 Griglia copripiletta in acciaio inox.
 Grate for sink waste in stainless steel.



696B € 0,73
 Griglia copripiletta in acciaio inox, Ø esterno mm 70.
 Grate for sink waste in stainless steel, external Ø 70 mm.



692 € 0,91
 Tappo in PVC nero, con maniglia Ø mm 52.
 Plug in black PVC, with handle Ø mm 52.



690
 Tappi con catena e anello, con rosetta copritappo.
 Plugs with chain and chain ring, with coverhole flange.

Ø	40 mm	47 mm	52 mm
	€ 1,80	€ 1,90	€ 1,80



691
 Tappi con catena e reggicatena, con rosetta copritappo.
 Plugs with chain, chain-ring and holder, with coverhole flange.

Ø	27 mm	31 mm
	€ 1,80	€ 1,70

ACCESSORI PER LAVELLO - SINK ACCESSORIES



900114 € 13,50
 Pilettoni sifoide per lavello con T.P., senza dado e codulo, 1"1/4.
 Trap waste for sink, with overflow, without nut and connection, 1"1/4.



903114 € 9,70
 Piletta simplex 1"1/4.
 Simplex waste 1"1/4.



903SM114 € 6,50
 Piletta gattinara, Ø 70. 1"1/4.
 Waste, Ø 70. 1"1/4



880 € 175,90
 Gruppo completo per fontanella, tipo universale, con rubinetto, con ritorno automatico.
 Fountains complete set, universal type with tap with automatic return.



Piletta per lavabo con o senza T.P.
 Sink waste, with or without overflow.

90810	1"	€ 11,10
908114	1"1/4	€ 14,30

ACCESSORI PER WC ED ORINATOI - WC AND ORINALS ACCESSORIES



699 € 2,10
Pull bianchi con catena a perline.
Pull handle for wc flushing tank, with C.P. chain.

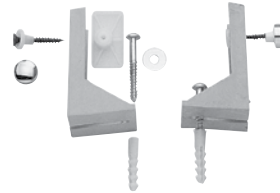

733 € 2,60
Coppia zanche in plastica antiurto a L con viti, per fissaggio laterale W.C. e bidet.
Couple wall brackets in plastic, shock-resistant, L shaped, with screws, for side WC and bidet fixing.



715 € 4,70
Confezione fissa water-bidet composta da 4 viti ottone, 4 dadi ottone, 4 sottoviti, 4 tasselli.
Bag for fixing W.C.-bidet: 4 brass screws, 4 caps, 4 underscrews, 4 nuts.



715F € 1,50
Confezione fissa water-bidet composta da 4 viti ferro, 4 dadi ottone, 4 sottoviti, 4 tasselli.
Bag for fixing W.C.-bidet: 4 iron screws, 4 caps, 4 underscrews, 4 brass nuts.



715F2 € 0,71
Confezione fissa water-bidet composta da 2 viti ferro, 2 dadi ottone, 2 sottoviti, 2 tasselli.
Bag for fixing W.C.-bidet: 2 iron screws, 2 caps, 2 underscrews, 2 brass nuts.



745 € 0,75
Coppia supporti per sedile WC, in nylon bianco completa di bulloni con guida.
Set of 2 holding brackets for WC seat, in white nylon, complete with bolts and slide way.



746 € 5,50
Coppia supporti per sedile WC, in ottone cromato con viti di fissaggio.
Set of 2 holding brackets in c.p. brass for WC seat, complete with bolts and slide way

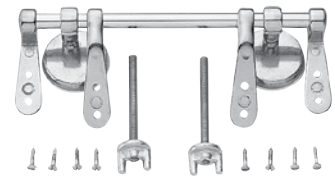

747 € 12,00
Coppia cerniere per sedile WC, in ottone cromato, tipo con tubetto per sedili in legno, con 8 viti in ottone.
Couple hinges for WC seat, in C.P. brass, kind with pipe for wooden seats, with 8 brass screws.

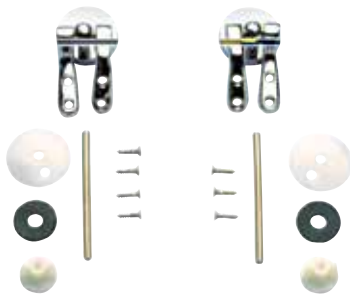

748 € 9,80
Coppia cerniere per fissaggio sedili W.C. in legno, con 8 viti in ottone.
Couple hinges for fixing W.C. seats, with 8 screws.

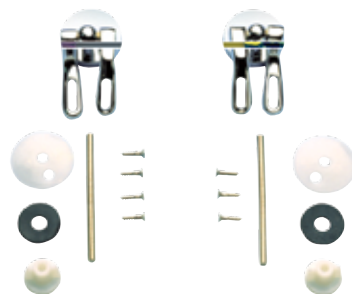

748UNI € 18,70
Coppia cerniere in ottone cromato, tipo universale, per fissaggio sedili W.C. in legno, con 8 viti in ottone.
Couple hinges in C.P. brass, universal type, for fixing W.C. seats, with 8 screws.



749 € 12,80
Coppia cerniere in ottone cromato, per sedile della serie Conca, con 8 viti ottone.
Couple hinges for WC seat serie Conca, in C.P. brass, with 8 brass screws.



Coppia viti con tassello in acciaio per lavabo, lunghezza mm 120, 140.
Bag of 2 screws 120, 140 mm for wash-basin, with plastic nuts.

750120 mm120 € 1,20

750140 mm140 € 1,40



Coppia viti per lavabo semi incasso con tassello, lunghezza mm 180.
Bag of 2 screws for semi-recessed basin, with nut, length mm 180.

751180 mm180 € 2,00



Coppia viti Ø mm 8 con tassello e dado per cassetta W.C., lunghezza mm 90.
Couple screws Ø mm 8 with plastic screw anchors and nut, for WC flushing tank, length mm 90.

75290 mm90 € 0,90



Coppia tiranti con gancio e tassello in acciaio per scaldabagno, lunghezza mm 75, 100.
Bag of 2 screws, 75, 100 mm for water-heater, with plastic nuts.

75575 mm75 € 0,81

755100 mm100 € 0,91

FLESSIBILI
FLEXIBLE HOSES

MINUTERIA
MINUTERY

VALVOLE
VALVES

RACCORDERIA
FITTINGS

ACCESSORI
ACCESSORIES

COMPONENTI PLASTICI
PLASTIC COMPONENTS

ACCESSORI - ACCESSORIES



Tassello di ricambio Ø6 e Ø8.

Spare dowel Ø 6 and Ø8..

77006 Ø6 € 0,04

77008 Ø8 € 0,05



850 € 29,70

Spartiacque curvo per orinatoio 1/2.
Elbow water divide for urinals, 1/2.



852 € 33,00

Spartiacque dritto per orinatoio 1/2.
Straight water divide for urinals, 1/2.



854 € 54,60

Piletta a cupola per orinatoio 1"1/4.
Urinal dome drain, 1"1/4.

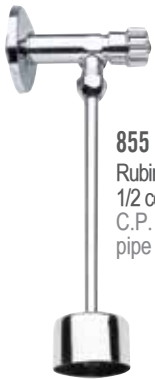

855 € 15,30
Rubinetto per orinatoio a maniglia,
1/2 con tubetto Ø mm 10 e rosoni.
C.P. urinal valve, 1/2, with copper
pipe Ø 10 and C.P. brass flanges.



856 € 28,30
Spartiacque per orinatoio attacco Ø
15, con tubo Ø mm 15.
Water divide for urinal, connection Ø 15,
with pipe Ø mm 15.



856CO € 17,50
Spartiacque per orinatoio attacco Ø 15,
per tubo Ø mm 15.
Water divide for urinal, connection Ø 15,
for pipe Ø mm 15.



872 € 47,70
Spartiacque curvo con canotto e rosone, per vasi
alla turca in ceramica in ottone cromato, 1".
Elbow water divide for "Turca" floor ceramic urinals in
c.p. brass, 1".



858 € 33,90
Bicchiere per scarico orinatoio, 1" in ottone cromato,
Ø interno mm 60.
Cup for urinal waste, in c.p. brass, internal Ø mm 60,
1".

ACCESSORI PER DOCCIA - SHOWER ACCESSORIES

Canaline Sifonate Rettangolari - Rectangulars Floor Drains



913RG12

Canalina sifonata a pavimento, in inox, con griglia di drenaggio, larghezza 12.5 cm lunghezze cm 70, 80, 90, 100, 120.
Rectangular floor drain, in stainless steel, with drain grill, large 12.5 cm, lengths cm 70, 80, 90, 100, 120.

cm70	cm80	cm90	cm100	cm120
€ 575,40	€ 617,40	€ 659,40	€ 701,40	€ 781,20

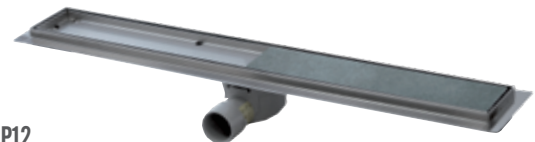

913RP12

Canalina sifonata a pavimento, in inox, piastrellabile, larghezza 12,5 cm lunghezze cm 70, 80, 90, 100, 120.
Rectangular floor drain, in stainless steel, model for tiling, large 12,5 cm, lengths cm 70, 80, 90, 100, 120.

cm70	cm80	cm90	cm100	cm120
€ 575,40	€ 617,40	€ 659,40	€ 701,40	€ 781,20

Pilette Sifonate - Siphon Drains



913SF10

€ 66,60

Piletta da pavimento sifonata in inox, cm 10x10.
Stainless steel floor drain and siphon, cm 10x10.



913SF15

€ 110,90

Piletta da pavimento sifonata in inox, cm 15x15.
Stainless steel floor drain and siphon, cm 15x15.



913SF20

€ 139,40

Piletta da pavimento sifonata in inox, cm 20x20.
Stainless steel floor drain and siphon, cm 20x20.

FLESSIBILI
FLEXIBLE HOSES

MINUTERIA
MINUTERY

VALVOLE
VALVES

RACCORDERIA
FITTINGS

ACCESSORI
ACCESSORIES

COMPONENTI PLASTICI
PLASTIC COMPONENTS

COPERTURA A PAVIMENTO IN ACCIAIO INOX - STAINLESS STEEL FLOOR DRAINS

10x10



913GVC10

€ 21,00

Copertura a pavimento in inox cm 10x10, con griglia fissa e coperchio mobile.
Stainless steel floor drain cm 10x10, with fixed grill and movable plug.



913GV10

€ 17,40

Copertura a pavimento in inox cm 10x10, con griglia fissa.
Stainless steel floor drain cm 10x10, with fixed grill.

15x15



913GVC15

€ 29,00

Copertura a pavimento in inox cm 15x15, con griglia fissa e coperchio mobile.
Stainless steel floor drain cm 15x15, with fixed grill and movable plug.



913GV15

€ 23,80

Copertura a pavimento in inox cm 15x15, con griglia fissa.
Stainless steel floor drain cm 15x15, with fixed grill.



913CV15

€ 23,80

Copertura a pavimento in inox cm 15x15, con coperchio avvitato fisso.
Stainless steel floor drain cm 15x15, with fixed plug.



913GFC15

€ 24,80

Copertura a pavimento in inox cm 15x15, con griglia e coperchio mobili.
Stainless steel floor drain cm 15x15, with movable grill and movable plug.

20x20



913VC20

€ 34,90

Copertura a pavimento in inox cm 20x20, con griglia fissa e coperchio mobile.
Stainless steel floor drain cm 20x20, with fixed grill and movable plug.



913GV20

€ 29,40

Copertura a pavimento in inox cm 20x20, con griglia fissa.
Stainless steel floor drain cm 20x20, with fixed grill.



913CV20

€ 29,40

Copertura a pavimento in inox cm 20x20, con coperchio avvitato fisso.
Stainless steel floor drain cm 20x20, with fixed plug.



913GFC20

€ 30,70

Copertura a pavimento in inox cm 20x20, con griglia e coperchio mobili.
Stainless steel floor drain cm 20x20, with movable grill and movable plug.

Sifoni Anti Scarafaggio - Anti Cockroach-Insects Trap



913PSA01

Sifone anti-scarafaggio da utilizzare per coperture a pavimento cm 15x15 e 20x20.
Anti cockroach-insects to use under the floor drains with size cm 15x15 e 20x20.

cm 15-20

€ 4,80



913PSA02

Sifone anti-scarafaggio da utilizzare per coperture a pavimento cm 10x10.
Anti cockroach-insects to use under the floor drains with size cm 10x10.

cm 10x10

€ 3,80

SCARICHI AUTOMATICI - POP-UP WASTES



95 € 12,90
Scarico automatico 1", 1"1/4.
C.P. brass pop-up waste, 1", 1"1/4.



95L80 € 16,60
Scarico automatico da 1"1/4, tipo Lusso.
C.P. brass pop-up waste 1"1/4, luxury type.



95LG80 € 25,40
Scarico automatico da 1"1/4, tipo lusso lucidato, con tappo grande a copertura totale della piletta.
C.P. polished pop-up waste, 1"1/4, luxury type with big plug covering the drain.



95P80 € 5,10
Scarico automatico in plastica da 1"1/4.
Plastic pop-up waste, 1"1/4.



95LS80 € 41,10
Scarico automatico da 1"1/4, tipo lusso lucidato, con tappo grande quadrato piatto a copertura totale della piletta.
C.p. polished pop-up waste, 1"1/4, luxury type with big squared flat plug covering the drain.



95AM € 27,20
Scarico tipo America o Americano, in ottone pulito e cromato.
C.p. waste model America or American, polished and in c.p. brass.

SCARICHI AUTOMATICI CLICK-CLACK - AUTOMATIC CLICK-CLACK POP-UP WASTES



904CC2114 € 31,40
Scarico automatico con sistema click-clack, 1"1/4, e tappo grande, senza troppo pieno, modello con bicchiere corto.
Automatic pop-up waste 1"1/4, click-clack system, big plug, without overflow, model with shorter cup.



904CC114 € 35,00
Scarico automatico con sistema click-clack, 1"1/4, e tappo grande, senza troppo pieno.
Automatic pop-up waste 1"1/4, click-clack system, big plug, without overflow.



904SCC2114 € 39,10
Scarico automatico quadrato 1"1/4 con click-clack senza troppo pieno, modello con bicchiere corto.
Squared automatic pop-up waste 1"1/4 with click-clack system without overflow, model with shorter cup.



904SCC114 € 42,80
Scarico automatico quadrato 1"1/4 con click-clack senza troppo pieno.
Squared automatic pop-up waste 1"1/4 with click-clack system without overflow.



906CC2114 € 27,70
 Scarico automatico con sistema click-clack, 1"1/4, con troppo pieno, modello con bicchiere corto.
 Automatic pop-waste 1"1/4, click-clack system, with overflow, model with shorter cup.



906CC114 € 31,40
 Scarico automatico con sistema click-clack, 1"1/4, con troppo pieno.
 Automatic pop-up waste 1"1/4, click-clack system, with overflow.



905CC2114 € 31,40
 Scarico automatico con sistema click-clack, 1"1/4, e tappo grande, con troppo pieno, modello con bicchiere corto.
 Automatic pop-up waste 1"1/4, click-clack system, big plug, with overflow., model with shorter cup



905CC114 € 35,00
 Scarico automatico con sistema click-clack, 1"1/4, e tappo grande, con troppo pieno.
 Automatic pop-up waste 1"1/4, click-clack system, big plug, with overflow.



905SCC2114 € 39,10
 Scarico automatico quadrato 1"1/4 con click-clack con troppo pieno, modello con bicchiere corto.
 Squared automatic pop-up waste 1"1/4 with click-clack system with overflow, model with shorter cup.



905SCC114 € 42,80
 Scarico automatico quadrato 1"1/4 con click-clack con troppo pieno.
 Squared automatic pop-up waste 1"1/4 with click-clack system with overflow.



9072114 € 42,40
 Scarico automatico 1"1/4 con tappo grande sempre aperto e sistema click-clack per la pulizia interna, modello con bicchiere corto.
 Automatic pop-up waste 1"1/4 with big plug always opened, and click-clack system for internal cleaning, model with shorter cup.



907114 € 45,90
 Scarico automatico 1"1/4 con tappo grande sempre aperto e sistema click-clack per la pulizia interna.
 Automatic pop-up waste 1"1/4 with big plug always opened, and click-clack system for internal cleaning.



905CCR114 € 32,50
 Scarico automatico universale con chiusura click-clack da 1"1/4.
 Universal automatic pop-up waste 1"1/4 with click-clack system.



905CCXL114 € 51,70
 Scarico automatico con sistema click-clack, 1" 1/4, tappo grande, con troppo pieno, versione extralunga.
 Automatic pop-up waste 1"1/4, click-clack system, big plug, with overflow, extralong version.

FLESSIBILI
FLEXIBLE HOSES

MINUTERIA
MINUTERY

VALVOLE
VALVES

RACCORDERIA
FITTINGS

ACCESSORI
ACCESSORIES

COMPONENTI PLASTICI
PLASTIC COMPONENTS

SIFONI - TRAPS



977114 € 23,00
Sifone a "P" in tubo, in ottone cromato, 1" 1/4".
"P" trap made by tube, in c.p. brass, 1" 1/4".



977X114 € 16,00
Sifone "P" in tubo, in acciaio INOX, 1" 1/4.
"P" trap made by tube, in stainless steel, 1" 1/4.



Sifone a bottiglia in ottone cromato, canotto cm 25, 1", 1" 1/4.
C.P. brass bottle trap, 25 cm outlet tube, 1", 1" 1/4,.

97010	1"	€ 29,00
970114	1"1/4	€ 34,00



970Z114 € 18,70
Sifone a bottiglia in zama senza piletta, per lavabo, 1" 1/4, canotto cm. 30.
Bottle trap in zamac without waste, for wash-basin, 1" 1/4, outlet tube cm 30.



Sifone a "S" in ottone cromato, canotto cm 25, 1", 1" 1/4.
C.P. brass "S" trap, 25 cm outlet tube, 1", 1" 1/4.

97110	1"	€ 29,90
971114	1"1/4	€ 32,40



971Z114 € 15,60
Sifone a "S" in zama, canotto cm 25, 1" 1/4.
"S" trap in zamac, 25 cm outlet tube, 1" 1/4.



972114 € 40,40
Sifone a "U" per lavabo a colonna in ottone cromato, canotto cm 25, 1" 1/4.
C.P. brass "U" trap, 25 cm outlet tube, 1" 1/4.

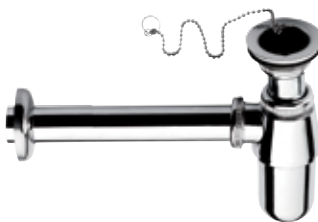

973Z114 € 24,60
Sifone a bottiglia in zama con piletta, per lavabo, 1" 1/4.
Bottle trap in zamac with waste, for wash-basin, 1" 1/4.

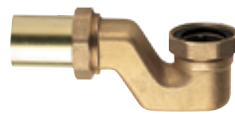

98112 € 27,70
Sifone pesante in ottone fuso, con dado 1" 1/2 per colonna vasca.
Heavy trap in casting brass, with nut 1" 1/2 for bath waste and overflow.



Ghiera per sifoni in ottone cromato, 1" M x 1" 1/4 F, 1" 1/4 M x 1" 1/2 F.
C.P. brass reduction for trap 1" M x 1" 1/4 F, 1" 1/4 M x 1" 1/2 F.

96810M114F	1" M x 1" 1/4 F	€ 3,90
968114M112F	1" 1/4 M x 1" 1/2 F	€ 4,70



Ghiera per sifoni in ottone cromato, 1" 1/4 M x 1" F, 1" 1/2 M x 1" 1/4 F.
C.P. brass reduction for trap 1" 1/4 M x 1" F, 1" 1/2 M x 1" 1/4 F.

969114M10F	1" 1/4 M x 1" F	€ 4,70
969112M114F	1" 1/2 M x 1" 1/4 F	€ 4,50

SIFONI - TRAPS

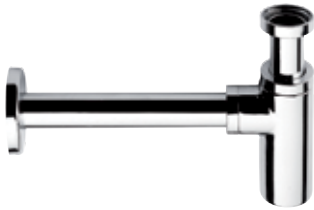

958L € 58,20
Sifone "MINIMAL" in ottone cromato, per lavabo, 1"1/4, canotto cm 30 e rosone pesante.
C.P. brass "MINIMAL" P trap, for wash-basin, 1"1/4, outlet tube cm 30 and heavy flange.

958B € 51,70
Sifone "MINIMAL" in ottone cromato, per bidet, 1"1/4, canotto cm 30 e rosone pesante.
C.P. brass "MINIMAL" P trap, for bidet, 1"1/4, outlet tube cm 30 and heavy flange.



960114 € 69,80
Sifone SQ, in ottone cromato, canotto cm 30, 1"1/4, con rosone pesante quadrato in ottone cromato.
C.p. brass SQ trap, 30 cm outlet tube, 1"1/4, with heavy square wall flange.

Sifone fuso pesante lusso in ottone cromato, per lavabo e bidet 1", 1" 1/4 canotto cm 30.
C.P. brass luxury "P" trap, heavy type, 1", 1" 1/4, outlet tube cm 30.

95610	1"	€ 27,10
956114	1"1/4	€ 47,10

SIFONI SALVASPAZIO - SPACE-SAVING TRAPS



985 € 198,50
Sifone salvaspazio con piletta click-clack incorporata con troppo pieno, rotondo, cromato.
Space-saving traps with click-clack built-in drain with overflow, round, chrome.

984 € 198,50
Sifone salvaspazio con piletta click-clack incorporata senza troppo pieno, rotondo, cromato.
Space-saving traps with click-clack built-in drain without overflow, round, chrome.

985S € 204,80
Sifone salvaspazio con piletta click-clack incorporata con troppo pieno, quadrato, cromato.
Space-saving traps with click-clack built-in drain with overflow, squared, chrome.

984S € 204,80
Sifone salvaspazio con piletta click-clack incorporata senza troppo pieno, quadrato, cromato.
Space-saving traps with click-clack built-in drain without overflow, squared, chrome.

FLESSIBILI
FLEXIBLE HOSES

MINUTERIA
MINUTERY

VALVOLE
VALVES

RACCORDERIA
FITTINGS

ACCESSORI
ACCESSORIES

COMPONENTI PLASTICI
PLASTIC COMPONENTS

COLONNE DI SCARICO - BATH WASTES



96P € 37,30
 Colonna di scarico automatica in plastica con filo esterno, senza dado e codulo.
 Plastic combined bath waste with automatic pop-up with external wire.



96PCC € 40,80
 Colonna di scarico in plastica, con pileta "click-clack".
 Plastic combined bath waste and overflow, "click-clack" waste system.



96LICC € 281,80
 Colonna di scarico con sifone per vasca con tubo in rame cromato e pileta click-clack, tutta cromata.
 Bath brass waste with siphon, trap, chromated copper tube and click clack waste, all in chrome plated.



96LIT € 213,20
 Colonna di scarico con sifone per vasca con tubo in rame cromato, tutta cromata.
 Bath brass waste with siphon, trap and chromated copper tube, all in chrome plated.

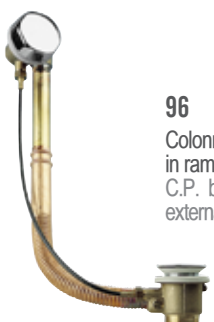

96 € 65,50
 Colonna di scarico automatica con filo esterno e tubo in rame senza dado e codulo.
 C.P. brass automatic bath waste and overflow with external wire and copper tube.

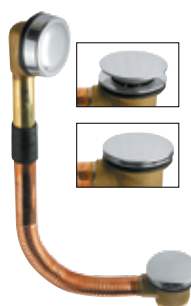

96CC € 56,20
 Colonna di scarico con tubo in rame, con pileta "click-clack".
 C.P. brass waste and overflow with copper tube and "click-clack" waste.



96VA € 77,90
 Colonna di scarico automatico con filo esterno e tubo in rame cm 70, per vasca ad angolo.
 C.P. brass automatic bath waste, overflow and copper tube, cm 70, for bath tube edge.

ACCESSORI - ACCESSORIES



910114 €16,20
Piletta doccia sifone, 1"1/4.
Trap drain for shower tray 1"1/4.



922100 € 8,30
Tappo ad espansione a 3 viti per
sifone a pavimento, Ø 100 mm.
Expansion plug with 3 nuts for floor
trap, Ø 100 mm.



918A € 4,10
Cestello pesante fuso in ottone cromato alto per
pilettone lavello.
C.p. brass high casted plug for sink waste.

918B € 3,90
Cestello pesante fuso in ottone cromato basso per
piletta vasca.
C.p. brass short casted plug for bathtub waste.



930 €1,70
Copritappo inox Ø mm 135, con vite
da 1/4.
Stainless steel plug cover Ø mm 135,
with 1/4 screw.



915CD114 € 5,20
Codulo diritto con dado, 1"1/4.
Straight connection with nut, 1"1/4.



915CC114 € 6,60
Codulo curvo con dado, 1"1/4.
Elbow connection with nut, 1"1/4.

ACCESSORI PER SCALDABAGNO - WATER HEATER ACCESSORIES



1111 €13,00
Resistenza per scaldabagno attacco 1"1/4
filettata, Watts 1200.
Straight heating element for water heater,
1"1/4, threaded cap, Watts 1200.

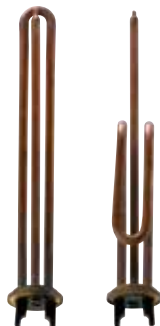

1121 €11,50
Resistenza per scaldabagno attacco con flangia,
Watts 1200.
Straight heating element for water heater, 1"1/4,
flanged cap, Watts 1200.



1121AR €13,20
Resistenza per scaldabagni Ariston, con flangia,
con tubetti prolungati, Watts 1200, 1"1/4.
Straight heating element for Ariston water heater,
1"1/4, flanged cap with longer pipes, Watts 1200.

1112 €13,60
Resistenza per scaldabagno ricurva attacco 1"1/4
filettata, Watts 1200.
Bent heating element for water heater, 1"1/4,
threaded cap, Watts 1200.

1122 €12,00
Resistenza per scaldabagno ricurva attacco con
flangia, Watts 1200.
Bent heating element for water heater, 1"1/4,
flanged cap, Watts 1200.

1122AR €13,50
Resistenza ricurva per scaldabagni Ariston, con
flangia, con tubetti prolungati, Watts 1200, 1"1/4.
Bent heating element for Ariston water heater,
1"1/4, flanged cap with longer pipes, Watts 1200.



1100 €7,70
Termostato per resistenza per scaldabagno, 1"1/4.
Round thermostat for water heater, 1"1/4.



1130 € 0,25
Guarnizione OR
mm 36,10x43,16x3,53
per resistenza flangiata.
Oring washer in NBR mm.
36,10x43,16x3,53, for flanged
heating elements.



1131 € 0,21
Guarnizione esente amianto
Ø 44x51, per resistenza filettata.
Asbestosfree washer for threaded
heating elements, Ø 44x51.



1132 € 0,25
Guarnizione in gomma anticalore
(EPDM) 755H, Ø 44,5x36x4, per
resistenza filettata.
Oring washer in EPDM, heating
resistant, 755 H mm. 44,5x36x4,
for threaded heating elements.

FLESSIBILI
FLEXIBLE HOSES

MINUTERIA
MINUTERY

VALVOLE
VALVES

RACCORDERIA
FITTINGS

ACCESSORI
ACCESSORIES

COMPONENTI PLASTICI
PLASTIC COMPONENTS



COMPONENTI PLASTICI PLASTIC COMPONENTS



COMPONENTI PLASTICI - PLASTIC COMPONENTS



FLESSIBILI
FLEXIBLE HOSES

MINUTERIA
MINUTERY

VALVOLE
VALVES

RACCORDERIA
FITTINGS

ACCESSORI
ACCESSORIES

COMPONENTI PLASTICI
PLASTIC COMPONENTS

COMPONENTI PLASTICI - PLASTIC COMPONENTS



551 € 3,00
Ermetic-past - Guamipast (cartoni da 60 barattoli) in barattoli da Kg. 0,500.
Ermetic-past - Guamipast, in cans of kgs 0,500 (each box contains 60 cans).



552 € 4,40
Extra Gas per impianti gas (cartoni da 60 barattoli) in barattoli da Kg.0,500.
Extra gas, for gas systems, in cans of kgs 0,500 (each box contains 60 cans).



555 € 10,30/Kg
Stearina in pacchi da Kg. 1.
Stearine in boxes of 1 Kg each.



570 € 12,50/Kg
Canapa pettinata in matassine 4x50 g, in balle da kg. 50.
Combed flax in small strips of 4x50 g, bags of 50 kg.

570BA € 3,90
Canapa pettinata in confezione da 250 g.
Combed flax in bags of 250 g.



140BL12 € 1,85
Tappo di collaudo impianti, filetto in ottone, blu, 1/2".
Testing plug, thread in brass, blue colour, 1/2.



140R012 € 1,85
Tappo di collaudo impianti, filetto in ottone, rosso, 1/2".
Testing plug, thread in brass, red colour, 1/2.



140BI12 € 1,85
Tappo di collaudo impianti, filetto in ottone, bianco, 1/2".
Testing plug, thread in brass, white colour, 1/2.



140BLPP € 1,05
Tappo di collaudo impianti, completamente in plastica blu, 1/2".
Testing plug, completely in plastic, blue colour, 1/2.



140R0PP € 1,05
Tappo di collaudo impianti, completamente in plastica rosso, 1/2".
Testing plug, completely in plastic, red colour, 1/2.



140BL12P € 0,78
Tappo di collaudo impianti, completamente in plastica, colore blu, filetto 1/2Mx3/4M.
Testing plug, completely in plastic, blu color, thread 1/2Mx3/4M.



140R012P € 0,78
Tappo di collaudo impianti, completamente in plastica, colore rosso, filetto 1/2Mx3/4M.
Testing plug, completely in plastic, red color, thread 1/2Mx3/4M.



140BI12P € 0,78
Tappo di collaudo impianti, completamente in plastica, colore bianco, filetto 1/2Mx3/4M.
Testing plug, completely in plastic, white color, thread 1/2Mx3/4M.



133 € 0,16
Rosetta apribile universale in plastica bianca.
Wall flange, universal type in white plastic.



134 € 0,35
Rosetta apribile universale in plastica bianca.
Wall flange, universal type in white plastic.

COMPONENTI PLASTICI - PLASTIC COMPONENTS



57210 € 0,35

Nastro P.T.F.E. in rullini da 1/2" per metri 10, spessore 0,075 mm.
P.T.F.E. Tape in rolls of 1/2", meters 10, thickness mm 0,075.

57212 € 0,40

Nastro P.T.F.E. in rullini da 1/2" per metri 12, spessore 0,075 mm.
P.T.F.E. Tape in rolls of 1/2", meters 12, thickness 0,075 mm.

57234 € 0,66

Nastro P.T.F.E. in rullini da 3/4, mm 19, per metri 12, spessore 0,075 mm. P.T.F.E. Tape in rolls of 3/4 (19 mm), meters 12, thickness 0,075 mm.

5721P € 0,95

Nastro P.T.F.E. in rullini da 1", mm 24, per metri 12, spessore 0,075 mm.
P.T.F.E. Tape in rolls of 1", (24 mm), meters 12, thickness 0,075 mm.



572 € 0,32

Nastro P.T.F.E. in rullini da 1/2" per metri 8, spessore 0,075 mm, stampato "RR".
P.T.F.E. Tape in rolls of 1/2", meters 8, thickness mm 0,075 with RR printed.



577 € 2,60

57715 metri 15 - meters 15 € 1,60

Nastro P.T.F.E. in rullini da mm 19,05 per metri 30, spessore mm 0,12, densità 0,30 g/cm³.
P.T.F.E. in rolls of 19,05 mm, meters 30, thickness 0,12 mm, 0,30 g/cm³ density.



553 € 11,90

Sigillante anaerobico flaconcino da 75ml.
Anaerobic sealant, 75ml vial.



573 € 1,50

Nastro P.T.F.E. giallo professionale per gas, in rullini da mm 12 per metri 10, spessore mm 0,10, densità 1,20 g/cm³.
P.T.F.E. professional yellow tape for gas, in rolls of 12 mm, meters 10, thickness 0,10 mm, 1,20 g/cm³ density.



574 € 0,55

Nastro P.T.F.E. in rullini da mm 12 per metri 12, spessore mm 0,10.
P.T.F.E. Tape in rolls of 12 mm, meters 12, thickness 0,10 mm.



575 € 2,00

Nastro P.T.F.E. professionale per gas in rullini da mm 19 per metri 15, spessore mm 0,20.
P.T.F.E. Professional Tape for gas, in rolls of 19 mm, meters 15, thickness 0,20 mm



579 € 18,00

Filo in P.T.F.E. professionale per ogni tipo di tubo in metallo e plastica di Ø inferiore a 6", per metri 150.
P.T.F.E. professional floss tape for pipe in metal or plastic, Ø up to 6", meters 150.



554 € 6,40/Kg

Liquido anticongelante ecologico puro tanica da 25kg.
Pure ecological antifreeze liquid. 25kg tank.

FLESSIBILI
FLEXIBLE HOSES

MINUTERIA
MINUTERY

VALVOLE
VALVES

RACCORDERIA
FITTINGS

ACCESSORI
ACCESSORIES

COMPONENTI PLASTICI
PLASTIC COMPONENTS

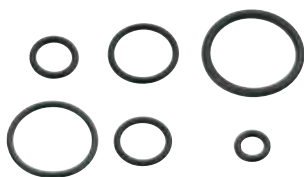

649

Anelli O'RING: in gomma NBR, rettificati, per tenuta a 120°C.
O-RINGS: in NBR rubber, applicable up to 120°C.

R3	8,0X4,2X1,9	€ 0,048	R7	12,7X8,9X1,9	€ 0,048
R4	8,7X4,9X1,9	€ 0,048	R8	14,3X8,9X1,9	€ 0,088
R5	9,5X5,7X1,9	€ 0,048	R9	15,9X10,5X1,9	€ 0,088
R5A	10,2X6,4X1,9	€ 0,048	R10	17,5X12,1X1,9	€ 0,088
R6	11,0X7,2X1,9	€ 0,048	R11	19,0X13,6X1,9	€ 0,088
R6A	11,8X8,0X1,9	€ 0,048	R12	20,5X15,1X1,9	€ 0,088



648

€ 12,40

Scatola con 430 anelli "OR" per vitoni del tipo originale rettificato, assortiti in 12 misure da Ø esterno mm 8 al Ø esterno mm 20,5.

Box of 430 "OR" rings, assorted in 12 measures from external Ø mm 8 to external Ø mm 20,5.



650

Guarnizioni per raccordi senza amianto spessore mm 2 in conf. 100 pz.

Green washers, without asbestos in bags of 100 pcs thickness.

3/8	1/2	3/4	
€ 0,028	€ 0,035	€ 0,055	
1"	1 1/4	1 1/2	2"
€ 0,065	€ 0,085	€ 0,13	€ 0,21

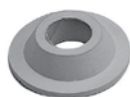

652

Guarnizioni coniche in gomma bianca.
Washer conical seat in white rubber.

1/2	3/4	
€ 0,32	€ 0,56	
1"	1 1/4	1 1/2
€ 0,45	€ 0,47	€ 0,70



653

Guarnizioni con bordino in gomma bianca.
Washer with reinforcement collar in white rubber.

1/2	3/4	
€ 0,24	€ 0,37	
1"	1 1/4	1 1/2
€ 0,37	€ 0,70	€ 0,70



Guarnizioni per radiatori in ghisa, spessore mm 2, misure 1", 1 1/4.

Washer for iron radiators, thickness mm 2, size 1", 1 1/4.

658210	1"	€ 0,24
6582114	1 1/4	€ 0,28



662FI

Guarnizione sede piana con filtro retinato.
Washer plain seat with net filter.

1/2	3/4
€ 0,32	€ 0,34



661CN18

€ 0,17

Guarnizioni sede tonda Ø18 in gomma NBR per canne lavello.

Washers round seat in black Ø18, rubber NBR, for sink spout.

659110

€ 0,18

Guarnizioni per radiatori in alluminio, spessore mm 1, 1".

Washer for aluminium radiators, thickness mm 1, size 1".

659210

€ 0,18

Guarnizioni per radiatori in alluminio, spessore mm 2, 1".

Washer for aluminium radiators, thickness mm 2, size 1".



661

Guarnizioni sede tonda in gomma NBR.
Washers round seat in black rubber NBR.

3/8	1/2	3/4
€ 0,07	€ 0,10	€ 0,10
1"	1 1/4	1 1/2
€ 0,11	€ 0,13	€ 0,18



662

Guarnizioni sede piana in gomma nera.
Washers plane seat in black rubber.

3/8	1/2	3/4
€ 0,07	€ 0,08	€ 0,09
1"	1 1/4	1 1/2
€ 0,11	€ 0,13	€ 0,13



663

Guarnizione sede conica in gomma nera.
Washer conical seat in black rubber.

3/8	1/2	3/4	
€ 0,11	€ 0,11	€ 0,11	
1"	Ø 30	1 1/4	1 1/2
€ 0,17	€ 0,14	€ 0,18	€ 0,21

COMPONENTI PLASTICI - PLASTIC COMPONENTS



Guarnizione sede rubinetto in gomma, collaudate a 200.000 chiusure con acqua a 80°.
Water taps sealing with hole, in rubber tested with 200.000 cycles.

66538	3/8	€ 0,18
66512	1/2	€ 0,20



Guarnizioni sede rubinetto in gomma, con foro.
Wall tap sealing with hole, in rubber.

66638	3/8	€ 0,08
66612	1/2	€ 0,09
66634	3/4	€ 0,18



Guarnizioni sede rubinetto in silicone bianche.
Water tap sealing in white sylicone.

666SI38	3/8	€ 0,11
666SI12	1/2	€ 0,13



Guarnizioni a scodellino in gomma nera.
Washer, cup shaped, in black rubber.

669185	Ø 18,5	€ 0,08
66921	Ø 21	€ 0,12
66924	Ø 24	€ 0,15



669CA € 0,23
Guarnizioni a scodellino per galleggiante Catis originale Ø 20 mm con perno.
Washer cup shaped for original Catis float valve, Ø 20 mm, with dowel.



669RE € 0,17
Guarnizioni a scodellino per galleggiante art. 176, 174 AS.
Washer cup shaped for ofloat valve art.176, 174 AS.



671PU € 1,30
Anello in para Ø esterno mm 60 - interno mm 44, sezione a U per cassetta Pucci.
Caoutchouc rubber external Ø mm 60, internal Ø mm 44, with U section for Pucci WC flushing tank.



671ID € 0,75
Guarnizione per Idronitor in para Ø esterno mm 68, Ø foro interno mm 33.
Washer for Idronitor in caoutchouc rubber, external Ø mm 68, internal hole Ø mm 33.



672KB € 0,57
Membrana in para Ø esterno mm 58,5, Ø foro mm 18,5 per cassetta Kariba.
Caoutchouc rubber flushing tank bottom seal washer, suitable for Kariba, external Ø mm 58,5, hole Ø mm 18,5.



672FA € 0,85
Membrana in para Ø esterno mm 63, Ø foro mm 22, per cassetta Fait.
Caoutchouc rubber flushing tank bottom seal washer, suitable for Fait, external Ø mm 63, hole Ø mm 22.



672ID € 0,79
Guarnizione per cassetta Idron in para nera, Ø est mm 56, Ø foro mm 25, spessore mm 3,6.
Caoutchouc rubber flushing tank bottom seal washer, suitable for Idron, external Ø mm 56 hole Ø mm 25, thickness mm 3,6.

FLESSIBILI
FLEXIBLE HOSES

MINUTERIA
MINUTERY

VALVOLE
VALVES

RACCORDERIA
FITTINGS

ACCESSORI
ACCESSORIES

COMPONENTI PLASTICI
PLASTIC COMPONENTS



673NDES € 4,30
Asta completa con sfera per cassetta Nuova Dora esterna.
Complete set of rod and ball for Nuova Dora external flushing tank.



673ND12 € 7,20
Asta completa con sfera per cassetta Nuova Dora incasso 12 litri.
Complete set of rod and ball for Nuova Dora built-in 12 liters flushing tank.

673ND14 € 7,50
Asta completa con sfera per cassetta Nuova Dora incasso 14 litri.
Complete set of rod and ball for Nuova Dora built-in 14 liters flushing tank.



679502632 € 1,30
Morsetto per W.C. in gomma nera, Ø esterno mm 50, per canotti Ø 26, 30, 32.
Clamp gasket for WC in black rubber, external Ø mm 50, for pipes Ø 26, 30, 32.



679552632 € 1,30
Morsetto per W.C. in gomma nera, Ø esterno mm 55, per canotti Ø 26, 30, 32.
Clamp gasket for WC in black rubber, external Ø mm 55, for pipes Ø 26, 30, 32.



6795540 € 0,93
Morsetto per W.C. in gomma nera, Ø esterno mm 55, per canotti Ø 40.
Clamp gasket for WC in black rubber, external Ø mm 55, for pipes Ø 40.



679602632 € 1,20
Morsetto per W.C. in gomma nera, Ø esterno mm 60, per canotti Ø 26, 30, 32.
Clamp gasket for WC in black rubber, external Ø mm 60, for pipes Ø 26, 30, 32.



674CA € 1,40
Valvola mezza sfera in para Ø est. mm 35, con nottolino ottone filetto 5/32 per batteria Catis.
Caoutchouc half sphere washer, external Ø mm 35, with brass nut, thread 5/32, for Catis group set.



674CASN € 1,10
Valvola mezza sfera in para Ø est. mm 35, senza nottolino ottone filetto 5/32 per batteria Catis.
Caoutchouc half sphere washer, external Ø mm 35, without brass nut, thread 5/32, for Catis group set.



676ND € 2,20
Sfera in para Ø esterno mm 55, con foro passante Ø mm 14, per cassetta Nuova Dora.
Ball in caoutchouc rubber for Dora WC flushing tank, external Ø mm 55, with passing hole Ø mm 14.



677 € 1,30
Raccordo per W.C. in para.
Connection for WC in caoutchouc rubber.



679 € 0,49
Morsetto per W.C. in gomma, Ø esterno mm 54, per canotti Ø 26, 30, 32.
Clamp gasket for W.C. in rubber, external Ø 54 mm, for pipe Ø 26, 30, 32.

COMPONENTI PLASTICI - PLASTIC COMPONENTS

FLESSIBILI
FLEXIBLE HOSES

MINUTERIA
MINUTERY

VALVOLE
VALVES

RACCORDERIA
FITTINGS

ACCESSORI
ACCESSORIES

COMPONENTI PLASTICI
PLASTIC COMPONENTS



680ST € 0,52
Morsetto per W.C. Standard in gomma bianca, Ø esterno mm 60, per canotti Ø 30, 32.
Clamp gasket for W.C. in white rubber, standard type, external Ø 60 mm, for pipe Ø 30, 32.



680ST40 € 1,30
Morsetto per W.C. Standard in gomma bianca, Ø esterno mm 60, per canotti Ø 40.
Clamp gasket for W.C. in white rubber, standard type, external Ø 60 mm, for pipe Ø 40.



6807532 € 3,50
Morsetto per W.C. Siphonic in gomma bianca, Ø est mm 75, per canotti Ø 30, 32.
Clamp gasket for WC Siphonic in white rubber, external Ø mm 75, for pipes Ø 30, 32.



6807540 € 3,60
Morsetto per W.C. Siphonic in gomma bianca, Ø est mm 75, per canotti Ø 40.
Clamp for WC Siphonic in white rubber, external Ø mm 75, for pipes Ø 40.



6825026 € 0,81
Raccordo in gomma nera Nicoll, Ø esterno mm 50, per canotti Ø 26.
Connector in black rubber Nicoll, external Ø 50 mm, for pipe Ø 26.



6825032 € 0,81
Raccordo in gomma nera Nicoll, Ø esterno mm 50, per canotti Ø 30, 32.
Connector in black rubber Nicoll, external Ø 50 mm, for pipes Ø 30, 32.



6825040 € 0,71
Raccordo in gomma nera Nicoll, Ø esterno mm 50, per canotti Ø 40.
Connector in black rubber Nicoll, external Ø 50 mm, for pipe Ø 40.



6833222 € 0,49
Guarnizioni in gomma per curve tecniche e manicotti Nicoll, foro mm 22, Ø esterno mm 32.
Rubber washer for technical bendings and Nicoll connections, hole mm 22, external Ø mm 32.



6834022 € 0,54
Guarnizioni in gomma per curve tecniche e manicotti Nicoll, foro mm 22, Ø esterno mm 40.
Rubber washer for technical bendings and Nicoll connections, hole mm 22, external Ø mm 40.



684502632 € 0,60
Raccordo in gomma nera per Von Roll, Ø esterno mm 50 per canotti Ø 26, 30, 32.
Connector in black rubber for Von Roll, external Ø 50 mm for pipes Ø 26, 30, 32.



6845040 € 0,51
Raccordo in gomma nera per Von Roll, Ø esterno mm 50 per canotti Ø 40.
Connector in black rubber for Von Roll, external Ø 50 mm for pipe Ø 40.



686472632 € 0,48
Raccordo in gomma nera per Geberit, Ø esterno mm 47 per canotti Ø 26, 30, 32.
Connector in black rubber for Geberit, external Ø 47 mm for pipes Ø 26, 30, 32.



6864740 € 0,35
Raccordo in gomma nera per Geberit, Ø esterno mm 47 per canotti Ø 40.
Connector in black rubber for Geberit, external Ø 47 mm for pipe Ø 40.

COMPONENTI PLASTICI - PLASTIC COMPONENTS



6873226 € 0,43

Raccordo in gomma nera per Redi, Ø esterno mm 32, per canotti Ø 26.
Fitting in black rubber for Redi, Ø external mm 32, for pipe Ø 26.



6874026 € 0,65

Raccordo in gomma nera per Redi, Ø esterno mm 40, per canotti Ø 26.
Fitting in black rubber for Redi, Ø external mm 40, for pipe Ø 26.



6874032 € 0,60

Raccordo in gomma nera per Redi, Ø esterno mm 40, per canotti Ø 32.
Fitting in black rubber for Redi, Ø external mm 40, for pipe Ø 32.



6875026 € 1,10

Raccordo in gomma nera per Redi, Ø esterno mm 50, per canotti Ø 26.
Fitting in black rubber for Redi, Ø external mm 50, for pipe Ø 26.



6875032 € 0,91

Raccordo in gomma nera per Redi, Ø esterno mm 50, per canotti Ø 32.
Fitting in black rubber for Redi, Ø external mm 50, for pipe Ø 32.



68811090 € 1,60

Collare sottovaso in gomma nera, Ø esterno mm 110, Ø interno mm 90.
Collar in black rubber for under WC bowl, internal Ø mm 90, external Ø mm 110.

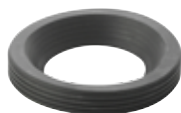

68812090 € 2,60

Collare sottovaso in gomma nera, Ø esterno mm 120, Ø interno mm 90.
Collar in black rubber for under WC bowl, internal Ø mm 90, external Ø mm 120.



689 € 5,50

Prolunga W.C. in gomma nera, Ø esterno mm 111, Ø interno mm 95, altezza mm 92.
Wc extension in black rubber, external Ø mm 111, internal Ø mm 95, thickness mm 92.



689B € 1,90

Prolunga W.C. in gomma bianca, Ø esterno mm 111, Ø interno mm 95, altezza mm 92.
W.C. white rubber connector, ext. Ø mm 111, int. Ø mm 95, height mm 92.



689EC € 1,90

Prolunga W.C. in gomma, eccentrica Ø esterno mm 138, Ø interno mm 100, altezza mm 100.
W.C. white rubber connector, eccentric, ext. Ø mm 138, int. Ø mm 100, height mm 100.



689ECL € 7,10

Prolunga W.C. in gomma, eccentrica Ø esterno mm 138, Ø interno mm 100, altezza mm 160.
W.C. white rubber connector, eccentric, ext. Ø mm 138, int. Ø mm 100, height mm 160.



689RI € 7,40

Prolunga W.C. in propilene, eccentrica Ø esterno mm 138, Ø interno mm 100, altezza mm 125.
W.C. white propylene connector, eccentric, ext. Ø mm 138, int. Ø mm 100, height mm 125.



698 € 0,48

Rullino per portarotoli in plastica bianca con molla inox.
Toilet roll holder rod in white plastic with stainless steel spring.



Ghiera per troppo pieno per lavabo e bidet, cromata.
C.P. Nut for basin and bidet overflow.

70024 Ø 13-19-24 € 0,75

70028 Ø 28 € 1,20



705 € 1,40

Copiforo per cassetta esterna, in Abs cromato.
Hole cover for external wc flushing tank, in c.p. Abs.



700D024 Ø13-19-24-28 € 5,30

Ghiera per troppo pieno per lavabo e bidet, dorata.
Golden nut for basin and bidet overflow.

COMPONENTI PLASTICI - PLASTIC COMPONENTS



Sifone in plastica regolabile con dado ottone 1"1/4, 1"1/2 per colonna, con scarico innesto Ø 40, 50, e a saldare. Adjustable low trap for bathtub in black PEHD, inlet nut 1"1/4, 1"1/2, outlet to weld Ø 40, 50.

98P114 1"1/4 € 7,30

98P112 1"1/2 € 7,30



Sifone in plastica regolabile con dado ottone 1"1/4, 1"1/2 per colonna, con scarico ad incollare Ø 32, 40, 50. Adjustable low trap for bathtub in grey PVC, inlet nut 1"1/4, 1"1/2, outlet to glue Ø 32, 40, 50.

98INC114 1"1/4 € 7,00

98NC112 1"1/2 € 7,60



911112 € 2,90
Sifone in plastica per vasca, 1"1/2 x 40. Siphon for bathtub in white P.P., 1"1/2 x 40.



912112 € 6,60
Piletta sifonata Ø 80 per piatto doccia 1"1/2x40. Waste and siphon for shower trays, in white P.P., S.S. grid Ø 80 mm, outlet plastic nut 1"1/2x40.



91490 € 8,80
Piletta per doccia con piastra cromata Ø 90, con uscita scarico Ø mm 40, per piatto doccia con foro Ø 60 mm. Waste for shower tray, with chrome plated cover Ø 90, outlet pipe mm 40, for shower tray with hole Ø 60 mm.



914120 € 15,70
Piletta per doccia con piastra cromata Ø 120, con uscita scarico Ø mm 40, per piatto doccia con foro Ø 90 mm. Waste for shower tray, with chrome plated cover Ø 120, outlet pipe mm 40, for shower tray with hole Ø 90 mm.



914GE € 13,80
Piletta doccia sifoide in plastica con attacco Geberit, piletta in ottone cromato, Ø 40, 50, a saldare. Siphon-waste for shower trays, in black PEHD, C.P. brass waste, outlet to weld Ø 40, 50 mm.



914INC € 18,40
Piletta doccia sifoide in plastica, piletta in ottone cromato, con attacco ad incollare, Ø 40, 50. Siphon waste for shower trays, in grey PVC, C.P. brass waste, outlet to glue Ø 40, 50 mm.



914NI € 13,80
Piletta doccia sifoide in plastica, piletta in ottone cromato, con attacco Nicoll, Ø 40. Siphon waste for shower trays, in white P.P., C.P. brass waste, outlet Ø 40, with 1"1/2 plastic nut.



Raccordo in plastica curvo per attacco Geberit Ø 40, con dado ottone, 1"1/4, 1"1/2. Elbow plastic connection for Geberit connection Ø 40, with brass nut 1"1/4, 1"1/2.

916114 1"1/4 € 3,20

916112 1"1/2 € 5,50



Raccordo in PVC curvo per attacco Nicoll, con dado ottone, 1"1/4, 1"1/2. Elbow connection in PVC for Nicoll connection, with brass nut, 1"1/4, 1"1/2.

917C114 1"1/4 € 5,60

917C112 1"1/2 € 5,60

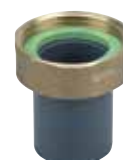

Raccordo in PVC diritto per attacco Nicoll, con dado ottone, 1"1/4, 1"1/2. Straight connection in PVC for Nicoll connection, with brass nut, 1"1/4, 1"1/2.

917D114 1"1/4 € 4,90

917D112 1"1/2 € 5,10

FLESSIBILI
FLEXIBLE HOSES

MINUTERIA
MINUTERY

VALVOLE
VALVES

RACCORDERIA
FITTINGS

ACCESSORI
ACCESSORIES

COMPONENTI PLASTICI
PLASTIC COMPONENTS

COMPONENTI PLASTICI - PLASTIC COMPONENTS



931 € 8,00
 Colonna vasca semplice in plastica con tubo di collegamento corrugato in P.P., 1"1/2.
 Corrugated plastic combined waste and overflow set for bathtub, in white P.P., S.S. grid, plug and chain. Male outlet 1"1/2.



932 1"1/2 € 8,40
 Colonna vasca semplice in plastica con tubo di collegamento estensibile in P.P., 1"1/2.
 Extensible plastic combined waste and overflow set for bathtub, in white P.P., S.S. grid, plug and chain. Male outlet 1"1/2.



933
 Canotto flessibile estensibile resistente da +90° a -10°C, colore bianco, con dado in plastica e un manicotto.
 Flexible and extensible plastic tube resisting from +90° to -10°C, white colour, with plastic nut and one coupling.

1" x Ø32 mm	1"1/4 x Ø32 mm	1"1/4 x Ø32/40 mm	1" x 1/2 x Ø40 mm	1"1/2 x Ø40/50 mm
€ 1,40	€ 1,60	€ 1,60	€ 1,60	€ 1,90



Canotto flessibile estensibile resistente da +90° a -10°C, colore bianco, con due manicotti, Ø manicotto mm 32, 40.
 Flexible and extensible tube resisting from +90° to -10°C, white colour, with double coupling Ø mm 32, 40.

93632	Ø 32	€ 1,60
93640	Ø 40	€ 1,60



933B
 Come 933, con dado in ottone, con rosone art. 933 RO.
 As 933, with brass nut and with flange art. 933 RO.

1" x Ø 32mm	1"1/4 x Ø 32mm	1"1/4 x Ø 32/40mm	1" x 1/2 x Ø 40mm	1"1/2 x Ø 40/50mm
€ 2,30	€ 2,30	€ 2,30	€ 2,40	€ 2,40



9331005SM2 € 3,90
 Set composto da canotto flessibile 1"1/2 x Ø mm 40 nostro articolo 933 112 40 + piletta simplex 1"1/2 ns articolo 1005SM112.
 Set composed by flexible and extensible plastic tube 1"1/2 x Ø mm 40 our article 933 112 40 + simplex waste 1"1/2 our article 1005SM112.



9331005SM4 € 4,00
 Set composto da canotto flessibile 1"1/4 x Ø mm 32/40 nostro articolo 933 114 3240 + piletta simplex 1"1/4 ns articolo 1005SM114.
 Set composed by flexible and extensible plastic tube 1"1/4 x Ø mm 32/40 our article 933 114 3240 + simplex waste 1"1/4 our article 1005SM114.

COMPONENTI PLASTICI - PLASTIC COMPONENTS



Rosone in plastica per art. 933, Ø mm 32, 40.
Plastic flange for art.933, Ø mm 32, 40.

933R032 Ø 32 € 0,21

933R040 Ø 40 € 0,21



933RI € 0,32
Riduzione in plastica per art. 933 1"1/2M x 1"1/4F.
Plastic reduction for art.933 1"1/2M x 1"1/4F.



933RI78112 € 0,32
Riduzione in plastica per art. 933 7/8"F x 1"1/2M.
Plastic reduction for art.933 7/8"F x 1"1/2M.

FLESSIBILI
FLEXIBLE HOSES

MINUTERIA
MINUTERY



943 € 13,30

Manicotto estensibile e flessibile per W.C. estensibile da 270 mm a 540 mm, resistente e rinforzato in acciaio, guarnizione universale da 90 a 110 mm.
Extensible plastic pipe connection for W.C. reinforced with metal spiral, extensible from 270 to 540 mm, diameter for W.C. from 90 mm to 110 mm.



944 € 7,60

Tubo estensibile per collegamento w.c., estensibile da mm 230 a mm 570, diametro raccordo w.c. da mm 90 a mm 110.
Flexible and extensible plastic tube for W.C., extensible from 230 mm to 570 mm, diameter for W.C. from 90 mm to 110 mm.

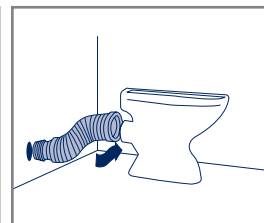
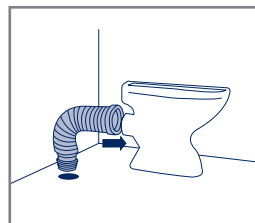
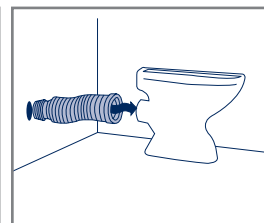
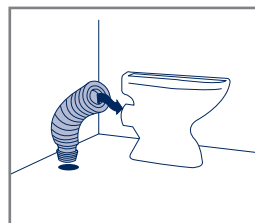

VALVOLE
VALVES

RACCORDERIA
FITTINGS



945C € 8,20

Manicotto per W.C., tipo corto, resistente e rinforzato con spirale in filo di nylon, guarnizione universale da 90 a 110 mm, lunghezza cm 40.
Flexible PVC plastic pipe connection for W.C. reinforced with nylon spiral, from 90 mm to 110 mm, length 40 cm.



945L € 8,70

Manicotto per W.C., tipo lungo, resistente e rinforzato con spirale in filo di nylon, guarnizione universale da 90 a 110 mm, lunghezza cm 55.
Flexible PVC plastic pipe connection for W.C. reinforced with nylon spiral from 90 mm to 110 mm, length 55 cm.

ACCESSORI
ACCESSORIES

COMPONENTI PLASTICI
PLASTIC COMPONENTS



943C € 19,70

Manicotto estensibile curvo per w.c., estensibile da 27 a 45 cm, senza troppo pieno.
Extensible plastic pipe with elbow for w.c., extensible from 27 to 45 cm, without overflow.



943CTP € 19,70

Manicotto estensibile curvo per w.c., estensibile da 27 a 45 cm, con troppo pieno.
Extensible plastic pipe with elbow for w.c., extensible from 27 to 45 cm, with overflow.

943CL € 20,20

Manicotto estensibile curvo per w.c., estensibile da 30 a 54 cm, senza troppo pieno.
Extensible plastic pipe with elbow for w.c., extensible from 30 to 54 cm, without overflow.

943CLTP € 20,20

Manicotto estensibile curvo per w.c., estensibile da 30 a 54 cm, con troppo pieno.
Extensible plastic pipe with elbow for w.c., extensible from 30 to 54 cm, with overflow.

COMPONENTI PLASTICI - PLASTIC COMPONENTS



Piletta in polipropilene per lavelli in ceramica, con griglia in acciaio, 1"1/4, 1"1/2.
Waste in polypropylene for ceramic sinks, with S.S. grid, 1"1/4, 1"1/2.

1005114	1"1/4	€ 2,40
1005112	1"1/2	€ 2,40



Piletta "Simplex" in polipropilene con griglia in acciaio, 1"1/4 (per lavelli in acciaio), 1"1/2 (per lavabo).
Simplex waste in polypropylene, with S.S. grid, 1"1/4 (for stainless steel sinks), 1"1/2 (for wash basin).

1005SM114	1"1/4	€ 2,50
1005SM112	1"1/2	€ 2,50



1025112 € 2,80
Piletta in polipropilene senza troppo pieno per lavelli in inox, 1"1/2.
Waste without overflow, in polypropylene, for stainless steel sinks, 1"1/2.



1028112 € 14,10
Piletta basket per lavelli, in polipropilene, con griglia e tappo inox, Ø 90 mm, (3"1/2, con filetto uscita 1"1/2).
Waste basket for sinks in polypropylene, with S.S. grid and plug, Ø 90 mm, (3"1/2, outlet thread 1"1/2).



1007 € 0,90
Riduzione 1"1/4Mx1"1/2F in polipropilene.
Reduction in polypropylene, 1"1/4Mx1"1/2F.



1020112 € 4,00
Piletta in polipropilene con troppo pieno per lavelli in inox, 1"1/2.
Waste with overflow, in polypropylene, for stainless steel sinks, 1"1/2.



1015 € 1,50
Attacco lavatrice universale in polipropilene, 1"1/2x40.
Extension pipe for washing machine, in polypropylene, universal type, 1"1/2x40



Sifone a fiasco a 2 vie senza pilette, in polipropilene.
Flask 2 ways trap in polypropylene without wastes.

101211432	1"1/4x32	€ 6,90
101211440	1"1/4x40	€ 6,90
101211232	1"1/2x32	€ 6,20
101211240	1"1/2x40	€ 6,20

COMPONENTI PLASTICI - PLASTIC COMPONENTS



Sifone a fiasco a 1 via senza piletta, in polipropilene.
Flask 1 way trap in polypropylene without waste.

101111432	1"1/4x32	€ 4,70
101111440	1"1/4x40	€ 4,70
101111232	1"1/2x32	€ 4,70
101111240	1"1/2x40	€ 4,70



Sifone tedesco in polipropilene senza piletta.
German bottle trap in polypropylene, without waste.

970P112	1"1/2	€ 4,70
970P114	1"1/4	€ 4,70



1233 € 8,70
Tubo di cacciata per cassetta alta,
universale (45°/90°, 90°/90°).
Connection pipe for high wc tanks,
universal type (45°/90°, 90°/90°).



12300R € 0,38
O-ring per art. 1233.
x O-ring for art. 1233.

FLESSIBILI
FLEXIBLE HOSES

MINUTERIA
MINUTERY

VALVOLE
VALVES

RACCORDERIA
FITTINGS

ACCESSORI
ACCESSORIES

COMPONENTI PLASTICI
PLASTIC COMPONENTS

Condizioni generali di vendita

Accettazione ordini

La commissione è sempre subordinata all'approvazione della Casa Venditrice. Le condizioni di vendita si intendono accettate dal committente al momento del conferimento dell'ordine e con il ritiro del materiale.

Consegne e rese

La merce è resa franco deposito di partenza e viaggio a rischio e pericolo del committente. Il venditore si riserva di poter effettuare consegne parziali.

Spedizioni

Le quantità devono essere verificate all'atto del ricevimento ed eventuali discordanze vanno annotate sulla bolla di consegna mediante accettazione "con riserva". Eventuali spese aggiuntive per giacenze sono a carico del committente.

Imballaggio

L'imballaggio è effettuato con imballi standard ed eventualmente su pallets a carico del committente.

Termini di consegna

I termini di consegna, eventualmente indicati, sono sempre forniti a puro titolo indicativo e non vincolante.

Prezzi

I prezzi riportati nei listini non sono vincolanti. La Remer Rubinetterie S.p.A. si riserva la facoltà di variare i prezzi di vendita in qualsiasi momento senza nessun preavviso.

Pagamenti

L'eventuale ritardo del pagamento comporterà l'addebito di interessi al tasso corrente. La Remer Rubinetterie S.p.A. si riserva la facoltà di sospendere eventuali ordini in corso in presenza di pagamenti irregolari. Le contestazioni di qualsiasi valore o entità non danno diritto alla sospensione dei pagamenti.

Reclami

Non si accettano reclami o resi merce dopo 7 giorni dal ricevimento della stessa. I reclami devono pervenire entro i termini indicati tramite lettera raccomandata e via fax. Ogni reso deve essere preventivamente autorizzato dalla Remer Rubinetterie S.p.A. che fornirà istruzioni in merito.

Caratteristiche tecniche

La Remer Rubinetterie S.p.A. si riserva il diritto di effettuare modifiche tecniche ed estetiche sui prodotti, senza preavviso alla clientela.

Riservato dominio

I prodotti rimangono di proprietà della Remer Rubinetterie S.p.A. fino al totale pagamento del prezzo in conformità a quanto previsto dal C.C.

Responsabilità

La Remer Rubinetterie S.p.A. non fornisce garanzie circa l'impiego errato o inadatto dei propri prodotti. Qualora il materiale risultasse difettoso per vizi di fabbricazione riconosciuti a seguito di perizia, la Remer Rubinetterie S.p.A. si riserva di sostituirlo o accreditarne il valore senza che la propria responsabilità si possa estendere in nessun caso ad altri oneri.

Foro

Per qualsiasi controversia il Foro competente è quello di Milano.

Stampato nel mese di Maggio 2021.

Sale conditions

Orders acceptance

The order is always subject to approval by the seller.

Delivers

The goods are delivered Ex Works and travel at the buyer's own risk. The seller reserves the right to execute partial consignments.

Forwarding

The quantities must be checked on receipt of the goods and any complaint must be made to the carrier. Any additional cost applied by the carrier will be charged to the buyer.

Packing

The goods are packed in standard packing on pallets charged to the customer.

Delivery terms

The delivery terms are always given as information and they never have to be considered as binding.

Prices

The prices shown on price list are not bending. Remer Rubinetterie S.p.A. reserves the right to modify the sales prices in any time with no prior warning.

Payments

Interest at the current rate will be charged for any delays in payment. Remer Rubinetterie S.p.A. reserves the right to delete any order on hand if the payments are not correct. Any complaint of whatever type or value do not give the right to suspend payments.

Complaints

Complaints and returned goods cannot be accepted after a period of 7 days from the arrival of the goods. Complaints must be made by mean of a registered letter or by fax within the terms stated. Any return of the goods must be authorized in advance by Remer Rubinetterie S.p.A. with instructions about it.

Technical specifications

Remer Rubinetterie S.p.A. reserves the right to carry out technical and aesthetical changes without previous notice to customers.

Lien

The products remain the property of Remer Rubinetterie S.p.A. until the cost has been paid in full, in accordance with the provisions of the C.C.

Liability

Remer Rubinetterie S.p.A. does not provide a guarantee covering the incorrect or the inappropriate use of its products. If the material should be substandard owing to manufacturing faults which are technical inspections, Remer Rubinetterie S.p.A. reserves the right to replace the material or to credit the value to the buyer. However under no circumstance does the company's liability extend to the payment of direct or indirect charges for other things.

Competent Court of Law

For any controversy that may arise the competent court of law is the one of Milan.

Printed on May 2021.

REMER
RUBINETTERIE



Ufficio Commerciale Italia:

Tel. 0363 364 333
Fax 0363 63 575

Remer Rubinetterie S.p.A.

Via Leonardo da Vinci, 83
20062 Cassano d'Adda (MI) Italy
Tel. +39 0363 364 211
info@remer.eu www.remer.eu

Export Commercial Department:

Tel. +39 0363 364 364
Fax +39 0363 364 300