

REMER
RUBINETTERIE



MADE IN ITALY 

PRICE ¹⁸⁻¹⁹ **LIST**

REMER

RUBINETTERIE



PRICE ¹⁸⁻¹⁹ LIST

FURNISH

DESIGN



Vanity P. 10



Infinity P. 20



Dream P. 30



Atmos P. 40



Class Line P. 46



Winner P. 58

ECO



Class Line Eco P. 138



Winner Eco P. 142

THERMOSTATIC



Elegance P. 146



Q-Elegance P. 152



Minimal Thermo P. 156



Qubika Thermo P. 166



Thermo P. 174

CLASSIC



Liberty P. 217



Musa P. 220



1000-2000 P. 226

SENSOR & TEMPOR



SENSOR
LED LIGHT
Sensor Color P. 234



Sensor P. 238



Tempor Touch P. 244



Tempor P. 248

FURNISH



Touch-Me Elegant kitchen P. 302



Touch-Me Gourmet P. 303



Touch-Me P. 304



Touch-Me Color P. 305



Color P. 306



Ambient P. 307



Electronic Purified Water P. 308



Purified Water P. 309

WELLNESS



Built-In Box P. 330



Wellness Kit P. 336

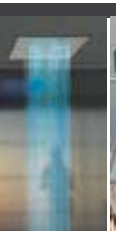

Color Therapie P. 358



Arms & Shower Heads P. 366



Shower Panels P. 380



Shower Columns P. 384



Sliding Rail P. 406



Hand showers P. 416



Shut-Off P. 424



Deck Bath Mixer P. 436



Spouts P. 442



Shower Flexibles P. 446

THE BATHROOM

REMER RUBINETTERIE



X Style P. 70



Minimal P. 78



Jazz P. 96



Q Design P. 104



Qubika P. 112



SQ3 P. 128

COLOR & TECHNOLOGY



Q-Color P. 178



Q-Ambient P. 184



Minimal Color P. 188

DESIGN WATERFALL



Flash P. 196



Qubika Cascata P. 204



Project P. 254



Ten P. 258



Giga Four P. 262



Kiss P. 266



Remix P. 272



35 P. 276



100 P. 280



Taps Accessories P. 282

THE KITCHEN

ELEGANT KITCHEN



Elegant Gourmet P. 310



Elegant Kitchen P. 314



Kitchen P. 316



Gourmet P. 318



Gourmet Coor P. 322



Deck Sink Mixer P. 324



304 INOX P. 326

BATH ACCESSORIES



LOUNGE P. 452



FLAT P. 454



DELICATA P. 456



MINIMAL INOX P. 458



900 P. 460



SQ P. 462



FORMA P. 464



ARTE P. 466



SUITE P. 468



EPOCA P. 470



Accessori P. 472



Hydro-Brush P. XX

REMER GROUP

ALWAYS IMPROVE TO EXCEED ITSELF AND SHOW YOU EVERY YEAR A NEW ZENITH



Founded in Milan in 1965, Remer Rubinetterie is a Leading manufacturer of faucets and minuterie, a serious and reliable Partner well-known on Italian and International Markets since over 50 years.

Remer is always oriented to satisfy the needs of a constantly changing market and to build stable business relationships.

Remer Rubinetterie's production is currently distributed in 140 Countries thus creating an important product and brand recognition and appreciation worldwide.

In order to perform big numbers, Remer has built wide production plants by investing in facilities, equipments and technologies to give to its customers more guarantee concerning quality and origin of its products.

Inside REMER own factories, between Milan and Bergamo, in the Remer Engineering Labs, entirely dedicated to high precision and quality production with highly innovative and completely robotic machinery, Remer fully complete the whole production cycle of most of its items.

Right since the design stage, the whole process of product creation is internal to our Company, that is equipped with the most structured research-and-development and technical departments in our industry sector, besides with advanced instruments.

After a careful selection and control of the best raw material suppliers, Remer proceeds to the production phase using only Italian and highly advanced machinery, Remer can machine casted items, forged items, brass bar items, brass tube items and brass plated, virtually the entire panorama.

Internal departments of polishing, chrome-plating and vanishing processes define and close the cycle of the product.

A plastics injection department also defines the substantial structure of the Group, together with the flexible hose braiding production department, and even more.

Tests and carefull assembly gives to each product the guarantee to be designed and created to last in time.

Through its production plants, Remer Rubinetterie gives to the customers a triple assurance on the product: the certainty of their origin, the safety of total quality, the best competitiveness in the market. REMER has focused on high technology to positively face the needs of an increasingly demanding market and the search for new solutions is the driving force behind the Group.

Remer Rubinetterie, by its nature, is constantly wishing to grow, invest, build, create, design, in order to give new results and new ideas in every season.

Remer Rubinetterie therefore invites you to appreciate not only the many new lines of products but also to make a little virtual tour of our Companies through our Company Video Presentation which transmits a little sample of our productive potential in both a visual and didactical way.

Structured on an area of about 90.000 square meters, 47.000 sqm covered and 2.000 sqm of offices only, the company is certified ISO 9001, company quality system, and ISO 14001, environmental quality system.

Remer Rubinetterie S.p.A., always attentive also to environmental issues, inaugurated in March 2011 a huge photovoltaic system that creates clean energy for 500KWp, the same energy needed by about 200 families and is about to inaugurate a new plant of 1000KWp, for a total of 1500KWp, to have its own production entirely GREEN!

This is Remer Rubinetterie, this is our Group and we work with passion.

We are confident that you too will appreciate this new catalog pricelist, an essential tool for professionals and an expression of a service that goes beyond the simple sale proposal but is a symbol of a real technical and commercial collaboration.

Antonio Repici



REMER main factory and offices.



REMER ENGINEERING 1
high-tech production, R&D.



REMER ENGINEERING 2
high-tech production.

REMER | THE STRENGTH OF A BIG GROUP

Polishing department, Test department,
Pre-assembly department,
Injection plastic pressing department,
Logistic department.

Head office and factory.

ENGINEEREENG 2
high-tech
production.

REMER
STORE

ENGINEEREENG 1
high-tech production.

 **FLEXITALY**
flexible hoses
production.



Cassano d'Adda (MI) - Italy
Lat: 45° 31' 37" N Long: 9° 30' 11" E

hystorical factory



REMER Polishing department, Test department,
Pre-assembly department, Injection plastic pressing department, logistic center.

FLEXITALY: production of flexibles.

OUR STRENGTH

OUR STRENGTH IS DETERMINED BY MANY FACTORS:

- Internal production of casted, forged, brass bar, sheet, brass tube items
- Internal production of plastic components
- 100% tested, guaranteed and risk free products
- Automatic test and assembly lines
- The entire production, assembly and logistics is automated, robotic and computerized
- Quality sales and post-sales assistance

- Internal production of several components included cartridges, headvalves, flexibles, diverters and many more
- 100% internal product cycle including both polishing, chrome plating and spray pain process
- 100% quality raw material, risk free and conform products
- Around 100 positions of computers in radio frequency
- Internal packaging production
- Quick delivery and constant availability of the product



Remer Rubinetterie S.p.A. is a UNI EN ISO 9001:2008 certified factory for the quality system and UNI EN ISO 14001: 2004 for environmental impact.





ONLY HIGH QUALITY AND MADE IN ITALY CARTRIDGES AND ELECTRONICS



All REMER mixers and products with electronic parts have an additional quality guarantee.

Ceramic disk cartridges for single-lever mixers, diverters for shower, thermostatic cartridges and electronic components are all produced in Italy by S.T.S.R. - Studio Tecnico Sviluppo e Ricerche - with plants in Lacchiarella - MI - and website www.stsr.it

S.T.S.R. was founded in 1985 as the Development and Research Technical Department of the Masco Multinational company, producing several patents related both to cartridges and electronic products over the years.

Inside there is cutting-edge machinery covering the production cycle from the molding of special plastics up to the assembly and testing of latest generation automatic machines.

Furthermore in S.T.S.R. there is a well-equipped analysis laboratory that daily performs various tests on its models to maintain control over the performance of its products.

S.T.S.R. products also have various certifications.

It is important for us to equip our mixers with a high quality cartridge; our customers can thus appreciate a purchase that guarantees long-term reliability and avoids the protracted complaints if the mixer is equipped with poor quality cartridges and sometimes with measures not easily available on the market, becoming a damage of image as well as of substance.

This added value gives to REMER articles superior characteristics as a confirmation of quality and of our made in ITALY.



ONLY MADE IN ITALY FLEXIBLE HOSES OF HIGH QUALITY MADE BY AUTOMATIC MACHINERIES FOR A PERFECT PRODUCT

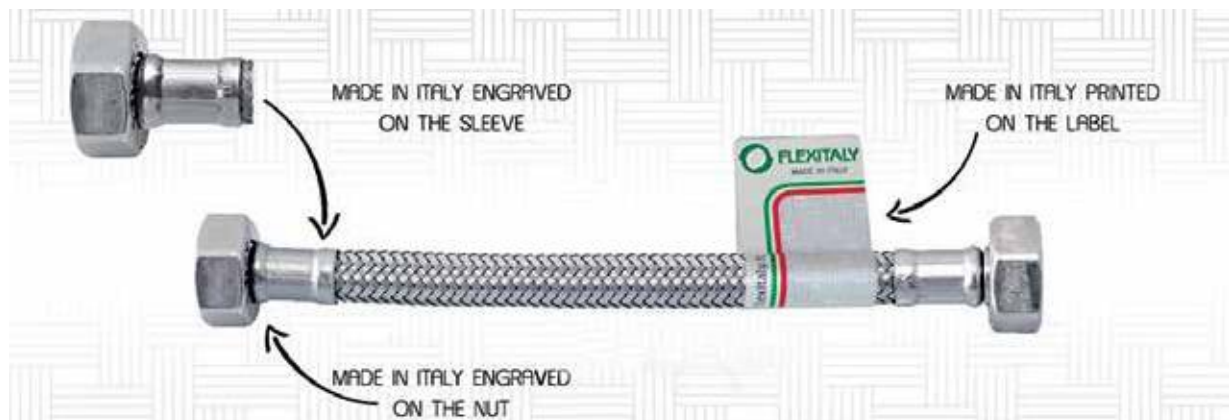

REMER products use only high quality flexible hoses produced in Italy with automated machinery in order to guarantee high standards. Flexitaly s.r.l., is a company belonging to the REMER Group. Founded in 1985, Flexitaly has its own plants, carrying on the production process starting from the hose braiding (epdm rubber and wire according to specification) and covering the entire production cycle with the help of

small parts and fittings created in-house with the best materials, carefully following the tolerances and specific automated machines, thus offering to customers a product completely made in Italy, designed and then created to be totally performing, non-toxic and extremely durable over time. A further plus for REMER products.



MADE IN ITALY 

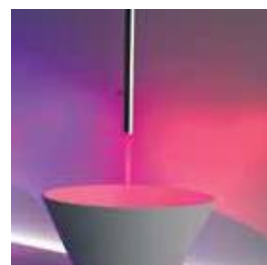
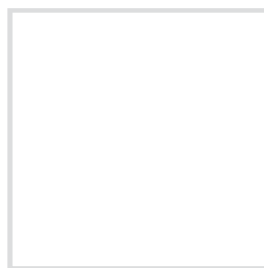
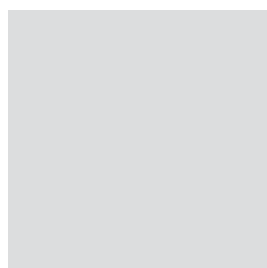
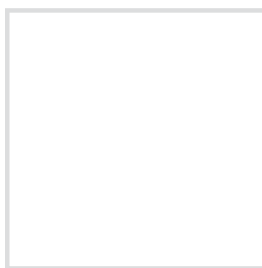

REMER
RUBINETTERIE



COLLECTION 18-19

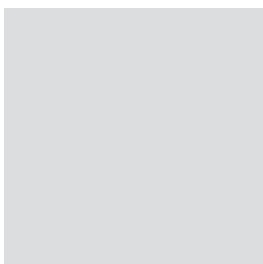
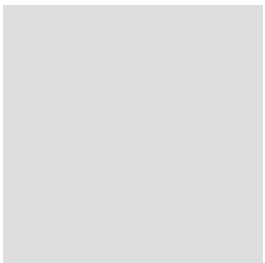
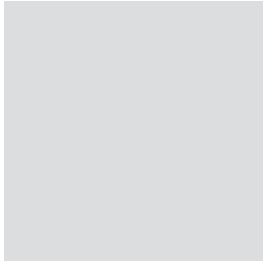
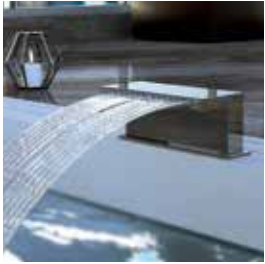

SENSOR COLOR



SENSOR COLOR

SENSOR

TEMPOR TOUCH

TEMPOR





SYMBOLGY:



The right proportion.



With Led Light



With Alkaline Batteries included



With Lithium Batteries included



With Angle Valve Filter Included



New Product



Available on request with anti-vandalism aerator and opening key, see article 83 AVC



All products are subject to change without notice. Information and materials included in these pages are subject to change.



The COLOR LED LIGHT technology is available in four variants named A, B, C, D. To highlight your selection please add the chosen letter at the end of the article number.

The use of sensor control taps facilitates water savings in public areas, ensuring both a high level of hygiene and an extremely high consumption control.

Adjusting the water flow through sensor technology ensures waste reduction, limiting the operating times only to actual needs.

The used electronics is produced within the Remer Group by the Italian company S.T.S.R. (Studio Tecnico Sviluppo e Ricerche - Development and Research Technical Department - Lacchiarella - Milan) and all products meet the CE certification standards.

A high security and precision technology, not affected by electromagnetic

sources or optical reflections, that activates the water supply by the recognition of a presence via infrared signals.

Sensors are equipped with an anti-vandal option that automatically blocks the water supply when reaching a fixed period of time. In addition, during periods of low usage, the sensor reactivity is set on a low-power mode that reduces the energy use of batteries.

In order to prevent impurities of water to get into contact with the mechanic parts and to preserve the quality of the product over time, the whole electronic faucets with the installation of stopcocks with filters for cleaning the incoming water supplied with the products.



SENSOR COLOR



SE 28R

Built in wash basin sensor mixer, single water or premixed, with color device.



GR € 864,50

TECHNICAL DATA:

- Working pressure: 1-5 Bar
- Water temperature max: 80° C max
- Input: Ø G 1/2 M
- Recognition range: about 10 cm adjustable
- Electrical connection: 4 lithium 1,5 V batteries type AA
- Adhesive Battery Holder IPX5.
- 2 selectable operation modes (low-consumption/high reactivity)
- CE approved.
- IP67 connections.



SE 18R

Sensor control basin mixer, with color device, with hot/cold water adjustment lever, angle valve with filter included.



GR € 855,30

TECHNICAL DATA:

- Working pressure: 1-5 Bar
- Water temperature max: 80° C max
- Input: Ø G 1/2 M
- Recognition range: about 10 cm adjustable
- Electrical connection: 4 lithium 1,5 V batteries type AA- Adhesive Battery Holder IPX5.
- 2 selectable operation modes (low-consumption/high reactivity)
- CE approved.
- IP67 connections.

A modern, minimalist bathroom sink with a sensor faucet and a soap dispenser. The sink is white and rectangular, set on a white countertop. The faucet is a sleek, chrome-finished sensor faucet with a long, horizontal spout. To the right of the sink is a cylindrical, chrome-finished soap dispenser with a pump handle. The background is a wall of light-colored, textured tiles. A dark horizontal bar is overlaid on the image, containing the word "SENSOR" in white, bold, uppercase letters.

SENSOR

SENSOR & TEMPOR

SENSOR COLOR

SENSOR

TEMPOR TOUCH

TEMPOR





SYMBOLGY:

 **PERFECT PROPORTION**
The right proportion.

 **COLOR LED LIGHT**
With Led Light

 **ALKALINE**
With Alkaline Batteries included

 **LITHIUM**
With Lithium Batteries included

 **FILTER**
With Angle Valve Filter Included

 **NEW**
New Product

 **CE**

Available on request with anti-vandalism aerator and opening key, see article 83 AVC



All products are subject to change without notice. Information and materials included in these pages are subject to change.



 
LITHIUM **CE**

SE 28
Built in wash basin sensor mixer, single water or premixed.

CR € 634,70



 
 
LITHIUM **CE**

SE 28 Q
Built in wash basin sensor mixer, single water or premixed.

CR € 601,50

TECHNICAL DATA:

- Working pressure: 1-5 Bar
- Water temperature max: 80° C max
- Input: Ø G 1/2 M
- Recognition range: 10 cm adjustable
- Electrical connection: 4 lithium 1,5 V batteries type AA
- Adhesive Battery Holder IPX5.
- 2 selectable operation modes (low-consumption/ high reactivity)
- CE approved.
- IP67 connections.



 
LITHIUM **CE**

SE 18
Sensor control basin mixer with hot/cold water adjustment lever, angle valves, with filter included.

CR € 625,50



 
 
LITHIUM **CE**

SE 25
Sensor control basin mixer for water premixed, with angle valves, with filter included.

CR € 574,10

SENSOR COLOR

SENSOR

TEMPOR TOUCH

TEMPOR





SENSOR

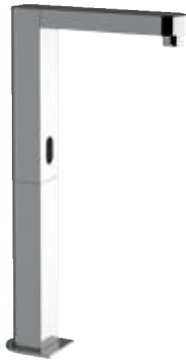

NEW



SE 17 L

CR € 486,60

High electronic tap, with sensor control, for pre-mixed water equipped with two angle valves with filter.

SE 16 L

CR € 426,80

High electronic single water tap, with sensor control, equipped with angle valve with filter.



SE 17

CR € 386,60

Electronic tap, with sensor control, for pre-mixed water equipped with two angle valves with filter.

SE 16

CR € 326,80

Electronic single water tap, with sensor control, equipped with angle valve with filter.

TECHNICAL DATA:

- Working pressure: 1-5 Bar
- Water temperature max: 80° C max
- Input: Ø G 1/2 M
- Recognition range: about 10 cm adjustable
- Electrical connection: 4 lithium 1,5 V batteries type AA
- Adhesive Battery Holder IPX5.
- 2 selectable operation modes. (low-consumption/high reactivity)
- CE approved.
- IP67 connections.





SE 15
Sensor control basin tap with single water, angle valve with filter included.

CR € 351,20



SE 15 B
Sensor control basin tap with single water and with base, angle valve with filter included.

CR € 376,70



SE 14
Sensor control mixer, with hot/cold water adjustment lever, angle valve with filter included.

CR € 455,60



SE 14 B
Sensor control mixer, with hot/cold water adjustment lever with base, angle valve with filter included.

CR € 481,10

TECHNICAL DATA:

- Working pressure: 1-5 Bar
- Water temperature max: 80° C max
- Input: Ø G 1/2 M
- Recognition range: about 10 cm adjustable
- Electrical connection: 4 lithium 1,5 V batteries type AA
- Adhesive Battery Holder IPX5.
- 2 selectable operation modes. (low-consumption/high reactivity)
- CE approved.
- IP67 connections.

SENSOR COLOR

SENSOR

TEMPOR TOUCH

TEMPOR



SE 30 CR € 277,60
Urinal electronic built-in flusher.

TECHNICAL DATA:

- Working pressure: 1 - 6 Bar
- Input: Ø G 1/2
- Control valve: solenoid valve
- Recognition range: 30-60 cm adjustable
- Electrical connection: DC 4.5 V with 3 1,5 V alkaline batteries type AAA
- Installation: built-in



SE 33 CR € 267,60
Urinal electronic external flusher.

TECHNICAL DATA:

- Working pressure: 1 - 6 Bar
- Input: Ø G 1/2
- Recognition range: 35 cm adjustable
- Electrical connection: DC 6V with 4 1,5 V alkaline batteries type AAA
- Installation: external mounted



SEPW KIT

€ 66,70

Kit composed of:
power supply jointer with battery back-up function and power supply 6V, in box (for use with alkaline batteries).



TEMPOR TOUCH

SENSOR & TEMPOR

SENSOR COLOR

SENSOR

TEMPOR TOUCH

TEMPOR





SYMBOLOLOGY:

 Tempor Touch

 With Angle Valve Filter Included

 With Alkaline Batteries included

 Wide coverage rain reduced flow Water saving



Available on request with anti-vandalism aerator and opening key, see article 83 AVC

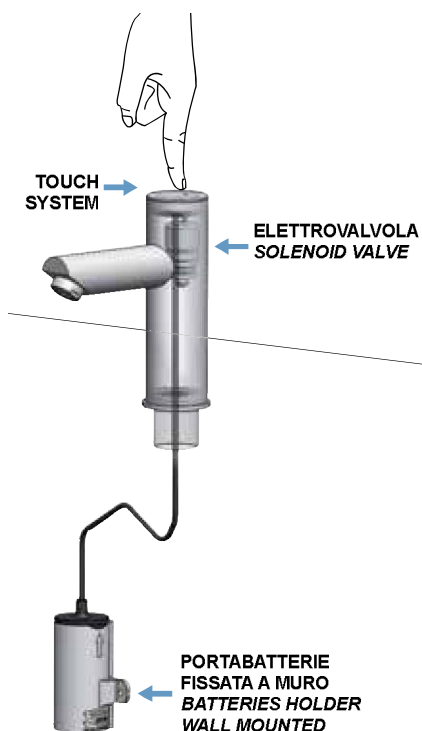

The electronic timing of TEMPOR TOUCH models uses PIEZO activation technology.

The water supply is activated by pressing a piezoelectric button and automatically stops after a while or upon request with a further subsequent pressing.

The two-timings version operates in the same way, allowing the user to select the desired timing before the valve opening through one or two button pressures and includes an optical feedback (two different led light colors instead of one of the single-timing version)

The technology employed in this product stands out thanks to its ability to elevate the level of precision and safety, and to ensure the desired performance even on multiple installations and/or on line.

The single-timing product is suggested where the user is always changing (airports, public toilets, etc) while the two-timing version is suggested where the users are commonly the same group (offices, home use, laboratories, medicals, etc).

1 Timing version: 10 seconds around (instantaneous water flow after the user press the button).

2 Timing version: around 10 seconds first timing, around 20 seconds second timing (a slight delay of about 1,5 seconds allows the user to select the necessary timing).

TEMPOR TOUCH



TTE 19 CR € 408,60
Electronic timing pillar tap with piezoelectric activation button, batteries powered, minimal squared shape, all in c.p. brass, opening time about 10 seconds, angle valve with filter included.

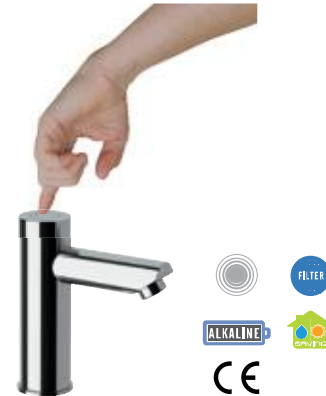

TTE 18 CR € 364,40
Electronic timing pillar tap with piezoelectric activation button, batteries powered, minimal round shape, all in c.p. brass, opening time about 10 seconds, angle valve with filter included.

TTE 219 CR € 408,60
Electronic timing pillar tap with piezoelectric activation button, batteries powered, minimal squared shape, all in c.p. brass, two times opening: first time opening about 10 seconds, second time about 20 seconds, angle valve with filter included.

TTE 218 CR € 364,40
Electronic timing pillar tap with piezoelectric activation button, batteries powered, minimal round shape, all in c.p. brass, two times opening: first time opening about 10 seconds, second time about 20 seconds, angle valve with filter included.



TTEQ 40 DW CR € 929,10
Three ways inlet squared single lever sink mixer, with movable spout, with selection for drinking water with piezoelectric activation button, with 2 independent exit aerators.

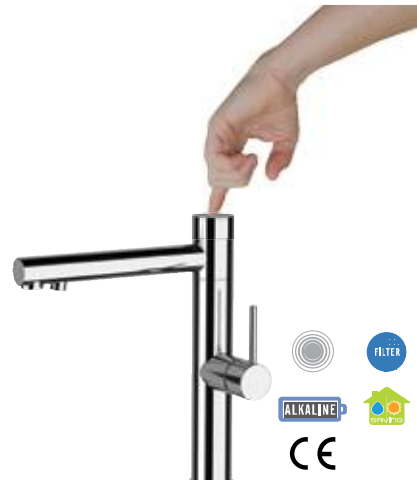

TTEN 40 DW CR € 759,80
Three ways inlet minimal single lever sink mixer, with movable spout, with selection for drinking water with piezoelectric activation button, with 2 independent exit aerators.

A close-up, low-angle shot of a white ceramic sink in a bathroom. The sink is the central focus, with its smooth, curved edges and a drain visible. To the right, a white soap dish holds a bar of light-colored soap. The background is a light-colored wall with two framed pieces of art. The lighting is soft and even, highlighting the clean, minimalist aesthetic of the space.

TEMPOR

SENSOR & TEMPOR

SENSOR COLOR

SENSOR

TEMPOR TOUCH

TEMPOR



WASHBASIN MIXERS



TE 15
Temporized (timer) pillar tap, 1/2", all in c.p. brass, opening time 6-8 seconds.



CR € 49,20



TE 16
Temporized (timer) pillar tap, 1/2", all in c.p. brass, opening time 6-8 seconds.



CR € 57,90



TE 18
Temporized (timer) pillar tap, 1/2", Minimal, all in c.p. brass, opening time 6-8 seconds.



CR € 70,20



TE 18 M
Temporized (timer) mixer pillar tap with hot/cold water selection handle, serie minimal. 1/2", in c.p. brass, opening time 6-8 seconds.



CR € 93,40



TE 19 M
Temporized (timer) mixer with water mixing through headvalve, pillar tap with hot/cold water selection handle, serie minimal. 1/2", in c.p. brass, opening time 6-8 seconds.



CR € 104,60



TE 19
Temporized (timer) pillar tap serie SQ, 1/2", all in c.p. brass, opening time 6-8 seconds.



CR € 95,60



TE 20
Temporized (timer) pillar tap, 1/2", all in c.p. brass, opening time 6-8 seconds.



CR € 78,80



TE 22
Temporized tap 1/2", oval line all in Cp brass opening time 6-8 seconds.



CR € 112,80



TE 225
Temporized (timer) frontal mounted 1/2" tap, all in c.p. brass, opening time 6-8 seconds.



CR € 43,50



TE 53
Temporized (timer) frontal mounted, with "S" spout, 1/2" tap, all in c.p. brass, opening time 6-8 seconds.



CR € 57,20



TE 42 S
Temporized (timer) upper mounted, with "U" spout, 1/2" tap, all in c.p. brass, opening time 6-8 seconds.



CR € 51,10



TE 42
Temporized (timer) upper mounted, with "J" spout, 1/2" tap, all in c.p. brass, opening time 6-8 seconds.



CR € 53,50



TE VI
Spare cartridge for temporized (timer) taps art. TE 15, TE 16, TE 53, TE 225, TE 855.



CR € 22,00

TOILET



TE 171
Temporized (timer) built-in tap, for wc, 3/4, 1", opening time 6-8 seconds.



CR € 74,80



TE 171Q
Temporized (timer) built-in squared tap for wc, 3/4, 1", opening time 6-8 seconds.



CR € 95,70



TE 170
Temporized (timer) wall mounted tap, for wc, all in c.p. brass, opening time 5-6 seconds: 3/4, 1".



3/4 € 55,70 1" € 59,10

SENSOR & TEMPOR

SENSOR COLOR

SENSOR

TEMPOR TOUCH

TEMPOR

332 TEL   **CR € 74,50**

Set composed by: shut-off handshower, flexible cm 120, temporized button flusher 1/2" all in c.p. brass, opening time 6-8 seconds.

TE 855   **CR € 51,00**

Temporized (timer) urinal button flusher, 1/2", in c.p. brass, in a set with flanges, two copper tubes Ø mm 14 and a washer. Opening time 6-8 seconds.

170 TU  **Ø 25 € 31,30 Ø 30 € 35,60**

"L" c.p. brass pipe, for wall mounted tempor tap for wc, Ø 25, 30.

RB 100 TE   **CR € 98,50**

Set composed by: hydro brush in c.p. brass, flexible cm 120, temporized button flusher 1/2" all in c.p. brass, opening time 6-8 seconds.

TE 856   **CR € 69,00**

Temporized (timer) urinal button flusher serie SQ, 1/2", in c.p. brass, in a set with flanges, two copper tubes Ø mm 14 and a washer. Opening time 6-8 seconds.

856  **CR € 26,90**

Water divide for urinals, connection Ø 15, with pipe Ø 15 mm.

SHOWER MIXERS

351 AVS   **CR € 63,60**



Antivandal and antiligature shower head with fix spray.

351 AV   **CR € 114,80**

Antivandal and antiligature shower head with adjustable spray.

TE 31   **CR € 54,90**

Temporized (timer) tap for shower, 1/2"x1/2", external, all in c.p. brass, opening time 18-20 seconds.

TE 30   **CR € 53,50**



Temporized (timer) wall mounted tap, 1/2", opening time 18-20 seconds.

TE VI 30  **CR € 21,20**

Spare cartridge for temporized (timer) taps art. TE 30 - TE 31.

TE 53 329EX 351    **CR € 73,10**

Temporized (timer) frontal mounted, with stand pipe 1/2" x 3/4" and standard shower head, opening time 25 seconds.

TE 30Q   **CR € 75,80**

Temporized (timer) wall mounted squared tap, 1/2", opening time 18-20 seconds.



DISPLAYERS

FLOOR DISPLAYERS



ESP Q € 650,00



ESP VERT € 336,00

AMBIENT MIXERS DISPLAYER



ESP AMB



€ 158,00



ESPLT 72

€ 498,60

Faucet with Touch-Me technology for demonstration purpose. In all the situations where it's not possible to connect the Touch faucet to the water supply, this DEMO version can simulate, when touching the mixer, the exact on/off of the water by turning on/off a blue light positioned in a very visible area by the aerator. The item is reprocessed for demonstration only.

SALE CONDITIONS

Orders acceptance

The order is always subject to approval by the seller.

Delivers

The goods are delivered Ex Works and travel at the buyer's own risk. The seller reserves the right to execute partial consignments.

Forwarding

The quantities must be checked on receipt of the goods and any complaint must be made to the carrier. Any additional cost applied by the carrier will be charged to the buyer.

Packing

The goods are packed in standard packing on pallets charged to the customer.

Delivery terms

The delivery terms are always given as information and they never have to be considered as binding.

Prices

The prices shown on price list are not bending. Remer Rubinetterie S.p.A. reserves the right to modify the sales prices in any time with no prior warning.

Payments

Interest at the current rate will be charged for any delays in payment. Remer Rubinetterie S.p.A. reserves the right to delete any order on hand if the payments are not correct. Any complaint of whatever type or value do not give the right to suspend payments.

Complaints

Complaints and returned goods cannot be accepted after a period of 7 days from the arrival of the goods. Complaints must be made by mean of a registered letter or by fax within the terms stated. Any return of the goods must be authorized in advance by Remer Rubinetterie S.p.A. with instructions about it.

Technical specifications

Remer Rubinetterie S.p.A. reserves the right to carry out technical and aesthetical changes without previous notice.

Lien

The products remain the property of Remer Rubinetterie S.p.A. until the cost has been paid in full, in accordance with the provisions of the C.C.

Liability

Remer Rubinetterie S.p.A. does not provide a guarantee covering the incorrect or the inappropriate use of its products. If the material should be substandard owing to manufacturing faults which are technical inspections, Remer Rubinetterie S.p.A. reserves the right to replace the material or to credit the value to the buyer. However under no circumstance does the company's liability extend to the payment of direct or indirect charges for other things.

Competent Court of Law

For any controversy that may arise the competent court of law is the one of Milan.

Printed on August 2018

Remer Rubinetterie S.p.A. reserves the right to introduce technical and aesthetical changes on all the articles, without previous notice to the customer.





Remer Rubinetterie S.p.A.
 Via Leonardo da Vinci, 83
 20062 Cassano d'Adda (MI) Italy
 Tel. +39 0363 364 211
 E-Mail: info@remer.eu
www.remer.eu

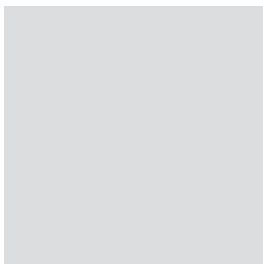
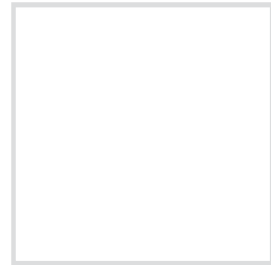

Ufficio Commerciale Italia:
 Tel. 0363 364 333
 Fax 0363 63 575
Export Commercial Department:
 Tel. +39 0363 364 364
 Fax +39 0363 364 300

