

**REMER**  
RUBINETTERIE



MADE IN ITALY 

**PRICE** 18-19 **LIST**



# REMER

RUBINETTERIE



## PRICE <sup>18-19</sup> LIST

# FURNISH

## DESIGN



Vanity P. 10



Infinity P. 20



Dream P. 30



Atmos P. 40



Class Line P. 46



Winner P. 58

## ECO



Class Line Eco P. 138



Winner Eco P. 142

## THERMOSTATIC



Elegance P. 146



Q-Elegance P. 152



Minimal Thermo P. 156



Qubika Thermo P. 166



Thermo P. 174

## CLASSIC



Liberty P. 217



Musa P. 220



1000-2000 P. 226

## SENSOR & TEMPOR



SENSOR  
LED LIGHT  
Sensor Color P. 234



Sensor P. 238



Tempor Touch P. 244



Tempor P. 248

# FURNISH



Touch-Me Elegant kitchen P. 302



Touch-Me Gourmet P. 303



Touch-Me P. 304



Touch-Me Color P. 305



Color P. 306



Ambient P. 307



Electronic Purified Water P. 308



Purified Water P. 309

# WELLNESS



Built-In Box P. 330



Wellness Kit P. 336



Color Therapie P. 358



Arms & Shower Heads P. 366



Shower Panels P. 380



Shower Columns P. 384



Sliding Rail P. 406



Hand showers P. 416



Shut-Off P. 424



Deck Bath Mixer P. 436



Spouts P. 442



Shower Flexibles P. 446

# THE BATHROOM

REMER RUBINETTERIE



X Style P. 70



Minimal P. 78



Jazz P. 96



Q Design P. 104



Qubika P. 112



SQ3 P. 128

## COLOR & TECHNOLOGY



Q-Color P. 178



Q-Ambient P. 184



Minimal Color P. 188

## DESIGN WATERFALL



Flash P. 196



Qubika Cascata P. 204



Project P. 254



Ten P. 258



Giga Four P. 262



Kiss P. 266



Remix P. 272



35 P. 276



100 P. 280



Taps Accessories P. 282

# THE KITCHEN

## ELEGANT KITCHEN



Elegant Gourmet P. 310



Elegant Kitchen P. 314



Kitchen P. 316



Gourmet P. 318



Gourmet Coor P. 322



Deck Sink Mixer P. 324



304 INOX P. 326

# BATH ACCESSORIES



LOUNGE P. 452



FLAT P. 454



DELICATA P. 456



MINIMAL INOX P. 458



900 P. 460



SQ P. 462



FORMA P. 464



ARTE P. 466



SUITE P. 468



EPOCA P. 470



Accessori P. 472



Hydro-Brush P. XX

# REMER GROUP

**ALWAYS IMPROVE TO EXCEED ITSELF AND SHOW YOU EVERY YEAR A NEW ZENITH**



Founded in Milan in 1965, Remer Rubinetterie is a Leading manufacturer of faucets and minuterie, a serious and reliable Partner well-known on Italian and International Markets since over 50 years.

Remer is always oriented to satisfy the needs of a constantly changing market and to build stable business relationships.

Remer Rubinetterie's production is currently distributed in 140 Countries thus creating an important product and brand recognition and appreciation worldwide.

In order to perform big numbers, Remer has built wide production plants by investing in facilities, equipments and technologies to give to its customers more guarantee concerning quality and origin of its products.

Inside REMER own factories, between Milan and Bergamo, in the Remer Engineering Labs, entirely dedicated to high precision and quality production with highly innovative and completely robotic machinery, Remer fully complete the whole production cycle of most of its items.

Right since the design stage, the whole process of product creation is internal to our Company, that is equipped with the most structured research-and-development and technical departments in our industry sector, besides with advanced instruments.

After a careful selection and control of the best raw material suppliers, Remer proceeds to the production phase using only Italian and highly advanced machinery, Remer can machine casted items, forged items, brass bar items, brass tube items and brass plated, virtually the entire panorama.

Internal departments of polishing, chrome-plating and vanishing processes define and close the cycle of the product.

A plastics injection department also defines the substantial structure of the Group, together with the flexible hose braiding production department, and even more.

Tests and carefull assembly gives to each product the guarantee to be designed and created to last in time.

Through its production plants, Remer Rubinetterie gives to the customers a triple assurance on the product: the certainty of their origin, the safety of total quality, the best competitiveness in the market. REMER has focused on high technology to positively face the needs of an increasingly demanding market and the search for new solutions is the driving force behind the Group.

**Remer Rubinetterie, by its nature, is constantly wishing to grow, invest, build, create, design, in order to give new results and new ideas in every season.**

Remer Rubinetterie therefore invites you to appreciate not only the many new lines of products but also to make a little virtual tour of our Companies through our Company Video Presentation which transmits a little sample of our productive potential in both a visual and didactical way.

Structured on an area of about 90.000 square meters, 47.000 sqm covered and 2.000 sqm of offices only, the company is certified ISO 9001, company quality system, and ISO 14001, environmental quality system.

Remer Rubinetterie S.p.A., always attentive also to environmental issues, inaugurated in March 2011 a huge photovoltaic system that creates clean energy for 500KWp, the same energy needed by about 200 families and is about to inaugurate a new plant of 1000KWp, for a total of 1500KWp, to have its own production entirely GREEN!

**This is Remer Rubinetterie, this is our Group and we work with passion.**

We are confident that you too will appreciate this new catalog pricelist, an essential tool for professionals and an expression of a service that goes beyond the simple sale proposal but is a symbol of a real technical and commercial collaboration.

*Antonio Repici*



REMER main factory and offices.



REMER ENGINEERING 1  
high-tech production, R&D.



REMER ENGINEERING 2  
high-tech production.

# REMER | THE STRENGTH OF A BIG GROUP

Polishing department, Test department,  
Pre-assembly department,  
Injection plastic pressing department,  
Logistic department.

Head office and factory.

ENGINEEREENG 2  
high-tech  
production.

REMER  
STORE

ENGINEEREENG 1  
high-tech production.

 **FLEXITALY**  
flexible hoses  
production.



Cassano d'Adda (MI) - Italy  
Lat: 45° 31' 37" N Long: 9° 30' 11" E

hystorical factory



REMER Polishing department, Test department,  
Pre-assembly department, Injection plastic pressing department, logistic center.

FLEXITALY: production of flexibles.

# OUR STRENGTH

## OUR STRENGTH IS DETERMINED BY MANY FACTORS:

- Internal production of casted, forged, brass bar, sheet, brass tube items
- Internal production of plastic components
- 100% tested, guaranteed and risk free products
- Automatic test and assembly lines
- The entire production, assembly and logistics is automated, robotic and computerized
- Quality sales and post-sales assistance
- Internal production of several components included cartridges, headvalves, flexibles, diverters and many more
- 100% internal product cycle including both polishing, chrome plating and spray pain process
- 100% quality raw material, risk free and conform products
- Around 100 positions of computers in radio frequency
- Internal packaging production
- Quick delivery and constant availability of the product



Remer Rubinetterie S.p.A. is a UNI EN ISO 9001:2008 certified factory for the quality system and UNI EN ISO 14001: 2004 for environmental impact.







**ONLY HIGH QUALITY AND MADE IN ITALY CARTRIDGES AND ELECTRONICS**



All REMER mixers and products with electronic parts have an additional quality guarantee.

Ceramic disk cartridges for single-lever mixers, diverters for shower, thermostatic cartridges and electronic components are all produced in Italy by S.T.S.R. - Studio Tecnico Sviluppo e Ricerche - with plants in Lacchiarella - MI - and website [www.stsr.it](http://www.stsr.it)

S.T.S.R. was founded in 1985 as the Development and Research Technical Department of the Masco Multinational company, producing several patents related both to cartridges and electronic products over the years.

Inside there is cutting-edge machinery covering the production cycle from the molding of special plastics up to the assembly and testing of latest generation automatic machines.

Furthermore in S.T.S.R. there is a well-equipped analysis laboratory that daily performs various tests on its models to maintain control over the performance of its products.

S.T.S.R. products also have various certifications.

It is important for us to equip our mixers with a high quality cartridge; our customers can thus appreciate a purchase that guarantees long-term reliability and avoids the protracted complaints if the mixer is equipped with poor quality cartridges and sometimes with measures not easily available on the market, becoming a damage of image as well as of substance.

This added value gives to REMER articles superior characteristics as a confirmation of quality and of our made in ITALY.



**ONLY MADE IN ITALY FLEXIBLE HOSES OF HIGH QUALITY MADE BY AUTOMATIC MACHINERIES FOR A PERFECT PRODUCT**

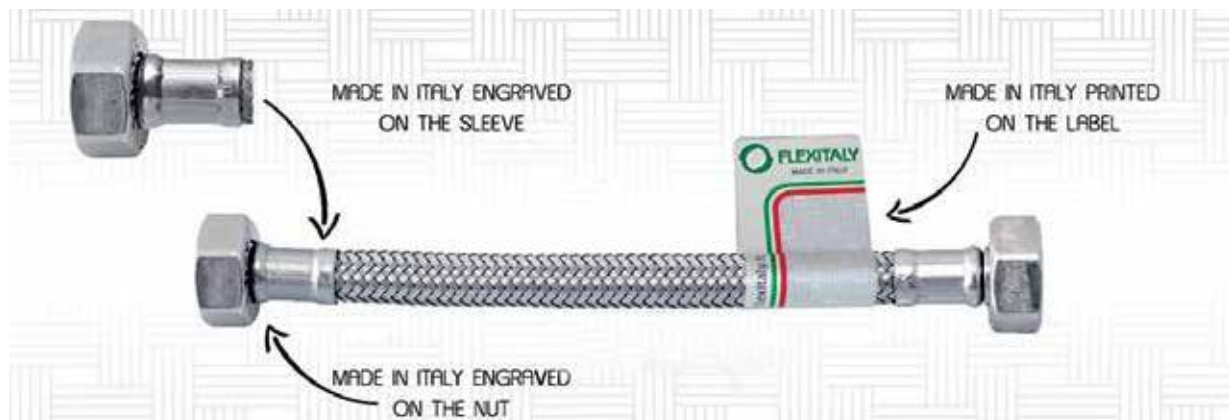

REMER products use only high quality flexible hoses produced in Italy with automated machinery in order to guarantee high standards. Flexitaly s.r.l., is a company belonging to the REMER Group. Founded in 1985, Flexitaly has its own plants, carrying on the production process starting from the hose braiding (epdm rubber and wire according to specification) and covering the entire production cycle with the help of

small parts and fittings created in-house with the best materials, carefully following the tolerances and specific automated machines, thus offering to customers a product completely made in Italy, designed and then created to be totally performing, non-toxic and extremely durable over time. A further plus for REMER products.



MADE IN ITALY 

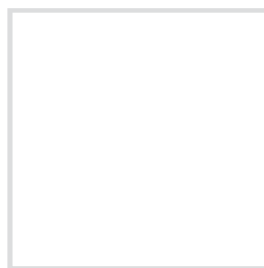
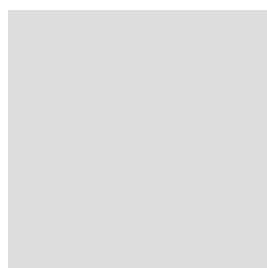
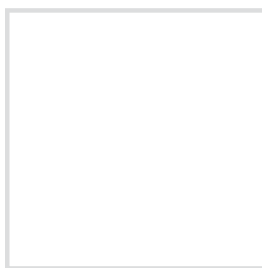

**REMER**  
RUBINETTERIE



# COLLECTION 18-19

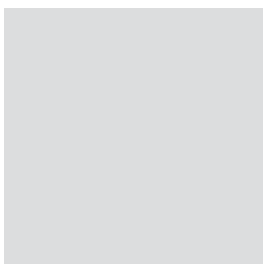
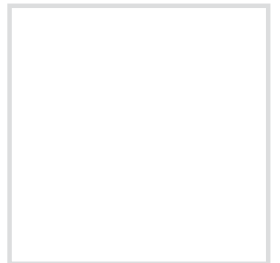
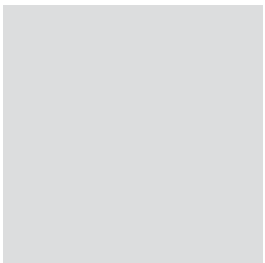
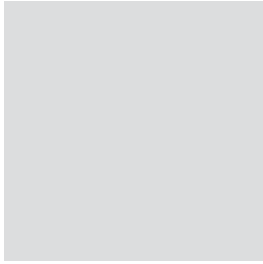
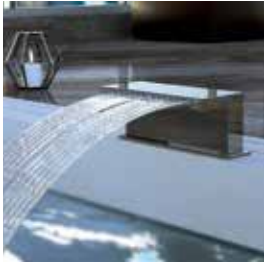

# TAPS ACCESSORIES



PROJECT

TEN

GIGA FOUR

KISS

REMIX

35

100

TAPS  
ACCESSORIES

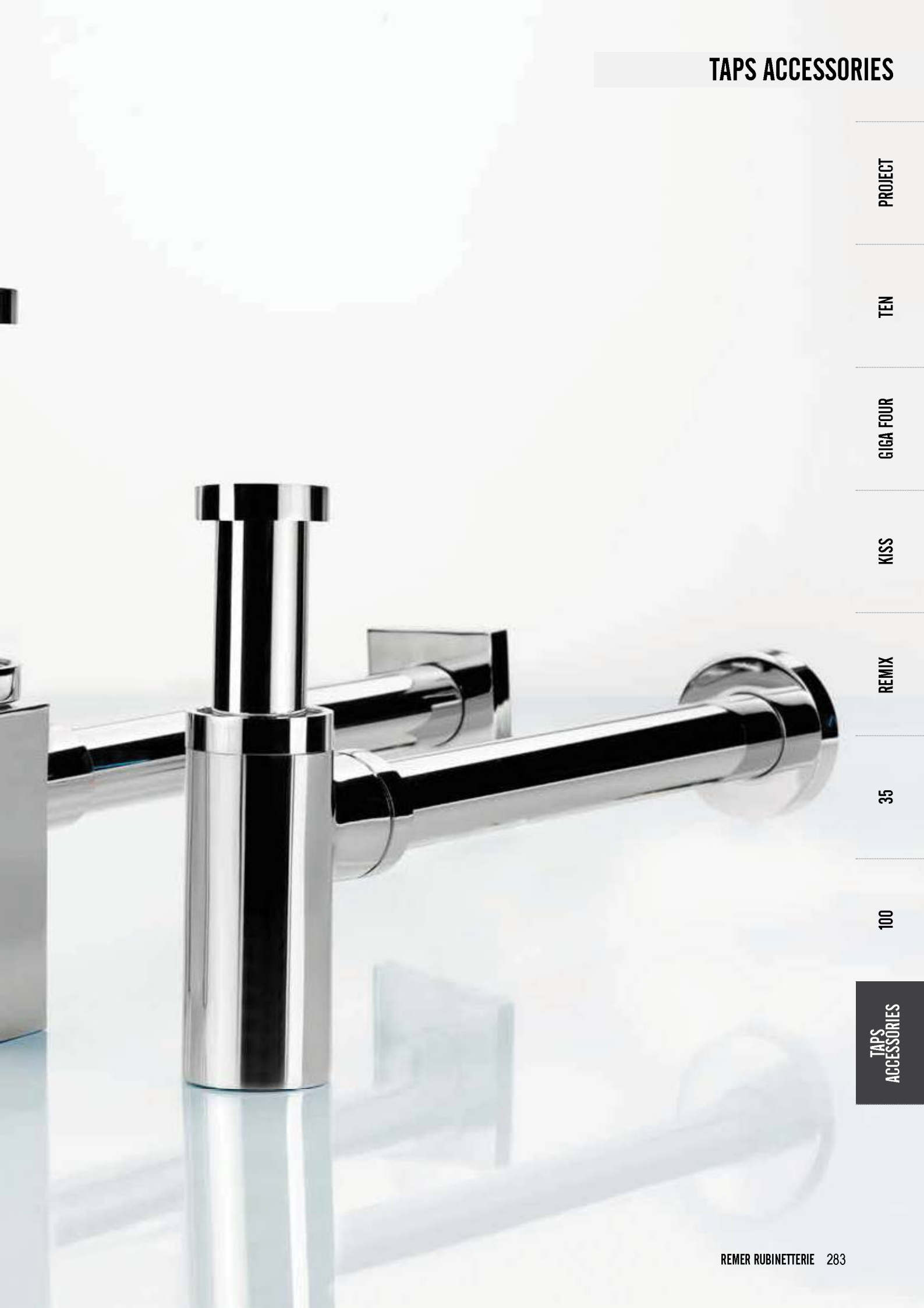

## TAPS ACCESSORIES

### SYMBOLOLOGY:



Movable  
spout.



High movable  
spout.

**NEW**

New Product



The right  
proportion.



## MIXERS

**61**



€ 30,30

Wall mounted long tap, 1/2, with long lever.

**63**



€ 33,70

Wall mounted hose-holder tap, 1/2, with long lever and S inferior spout.

**64**



€ 63,60

Wall mounted mixer, with long levers and S inferior spout.

**14 LL**



€ 75,30

Sink mixer bridge type, with long lever and spout Ø 18 mm.

**65**



€ 39,40

Wash basin pillar tap, 1/2, with long lever.

**61 LE**



€ 10,60

Lever for art. 61, 63, 64, 65, 14LL.

**MA 14**



€ 22,00

Spare long lever for single lever mixers with Ø 40 cartridge.

**61 VI**



€ 5,00

Head valve 1/2 for articles 61, 63, 64, 65, 14LL.

**66**



€ 120,40

Built in tap foot operated, in c.p. brass.

**66 MP**



€ 128,20

Treadle mixer with universal pedal control. It can be installed both on the wall and on the floor.

**67**



€ 43,30

Movable spout for washbasin.

**67 N**



€ 62,20

Minimal high spout.

**67 Q**



€ 90,70

Squared high spout.

**69**



€ 56,40

Parabolic jet button tap for refrigerator or purifier. Water flow control under the button.

## CARTRIDGES



**P 50**

€ 23,40

Ceramic cartridge Ø 35, with distributors, with flow shut-off and water outlet towards the low.



**P 52**

€ 23,40

Ceramic cartridge Ø 35, without distributors, with flow shut-off and water outlet towards the low.



**V 50 C**

€ 21,40

Ceramic cartridge Ø 25 mm, flat bottom type



**V 50 A**

€ 21,40

Ceramic discs cartridge Ø 25, with water outlet directly from the top part of the cylindric shell without being joined towards the bottom of the cartridge.



**J 50**  
Ceramic cartridge Ø 35 mm, "joystick" movement, flat bottom type

€ 19,50



**E 50 C**  
Thermostatic coaxial cartridge serie MINIMAL THERMO and QUBIKA THERMO.

€ 88,10



**E 50 P**  
Thermostatic cartridge with 330° angular handle rotation, 38° safety lock, working field from 5°C to 80°C, pressure field from 1 to 10 bar, stainless steel filter and safety system with the outlet lock in case there is one water lock, high performance thermoplastic materials.

€ 38,70



**E 50**  
Thermostatic cartridge with 330° angular handle rotation, 38° safety lock, working field from 5°C to 80°C, pressure field from 1 to 10 bar, stainless steel filter and safety system with the outlet lock in case there is one water lock.

€ 48,70

## CARTRIDGES IN BLISTER



**S 50**  
Ceramic cartridge Ø 40 mm for bath, wash basin, bidet (type with distributor).

€ 9,40



**S 52**  
Ceramic cartridge Ø 40 mm for sink and shower (flat bottom type).

€ 9,40



**R 50**  
Ceramic cartridge Ø 35 mm for bath, wash basin, bidet (type with distributor).

€ 9,40



**R 52**  
Ceramic cartridge Ø 35 mm for sink and shower (flat bottom type).

€ 9,40



**S 50 AF**  
Forced opening ceramic cartridge Ø 40 mm for bath, wash basin, bidet (type with distributors) permit a remarkable saving of water.

€ 11,40

CLICK SYSTEM



**S 52 AF**  
Forced opening ceramic cartridge Ø 40 mm for sink, shower (flat bottom type) permit a remarkable saving of water.

€ 11,40

CLICK SYSTEM



**R 50 AF**  
Forced opening ceramic cartridge Ø 35 mm for bath, wash basin, bidet (type with distributors) permit a remarkable saving of water.

€ 11,40

CLICK SYSTEM



**R 52 AF**  
Forced opening ceramic cartridge Ø 35 mm for sink, shower (flat bottom type) permit a remarkable saving of water.

€ 11,40

CLICK SYSTEM



**W 50**  
Ceramic cartridge Ø 35 mm for sink, shower, bath, bidet (flat bottom type).

€ 19,50

PROJECT

TEN

GIGA FOUR

KISS

REMIX

35

100

TAPS ACCESSORIES

DIVERTERS



**Q 34 DEV 5**

CR € 247,60

Shower 5 outlet way diverter (1 inlet way and 5 outlet ways) on flange, for Qubika serie.



**Q 93 DEV 3**

CR € 231,80

Three ways diverter (1 inlet and 3 outlets) on flange, Qubika serie.



**Q 93 DEV 7**

CR € 231,80

Three ways diverter with seven positions (1 inlet and 3 outlets and seven positions to select single or mixed outlets) on flange, Qubika serie.



**N 34 DEV 5**

CR € 229,80

Shower 5 outlet way diverter (1 inlet way and 5 outlet ways) on flange, for Minimal serie.



**N 93 DEV 3**

CR € 203,00

Three ways diverter (1 inlet and 3 outlets) on flange, Minimal serie.



**N 93 DEV 7**

CR € 203,00

Three ways diverter with seven positions (1 inlet and 3 outlets and seven positions to select single or mixed outlets) on flange, Minimal serie.

EXTENSIONS



**K 09 PROL**

€ 60,00

Extension for built-in shower mixer body with diverter for cartridge Ø 40 mm.



**N 09 PROL**

€ 60,00

Extension for built-in shower mixer body with diverter for cartridge Ø 35 mm.



**S 52 PROL**

€ 25,60

Extension for built-in shower mixer body with cartridge Ø 40 mm.



**R 52 PROL**

€ 25,60

Extension for built-in shower mixer body with cartridge Ø 40 mm.

AUTOMATIC DIVERTERS



**78**

€ 0,15

Screw for fixing handle.



**80 SN**

€ 0,99

Joint with screw for pop-up waste.



**DEV 00**

€ 8,60

Automatic brass diverter with spring and lock for low pressure.



**DEV 08**

€ 10,50

Automatic brass diverter with spring and lock, mm 8 extended in 1/2 side.



**DEV 13**

€ 12,10

Automatic brass diverter with spring and lock, mm 13 extended in 1/2 side.



## HEADVALVES



**75**  
 Universal headvalve for taps, allow to create 102 different combinations of lengths and sizes. Packed in a safe skin-pack.

€ 21,10



**77 19**  
 19/19 Head valve thread, for built-in stop cocks.

€ 4,20



**74**  
 Head valve 1/2" for bath, sink, wash basin, bidet and built-in stop cock for art. 53, 55.

€ 3,40



**74 E** € 2,60  
 As 74, light type.



**74 F** € 3,60  
 Head valve 1/2 with thread M24x1 for head valve cover.



**77 18** € 2,60  
 18/19 Head valve thread for art. 221, 223, 224, 250, 252 and others.



**77 38** € 2,60  
 3/8 Head valve thread, for taps.



**76 DX 180** € 7,60  
 Head valve 180° ceramic discs, broach Ø 8 mm, 20 teeth, right.



**76 DX 24** € 7,60  
 Head valve 90° ceramic discs, broach Ø 8 mm, 24 teeth, right.



**76 DX** € 7,60  
 Head valve 90° ceramic discs, broach Ø 8 mm, 20 teeth, right.



**76 SX 180** € 7,60  
 Head valve 180° ceramic discs, broach Ø 8 mm, 20 teeth, left.



**76 SX 24** € 7,60  
 Head valve 90° ceramic discs, broach Ø 8 mm, 24 teeth, left.



**76 SX** € 7,60  
 Head valve 90° ceramic discs, broach Ø 8 mm, 20 teeth, left.

PROJECT

TEN

GIGA FOUR

KISS

REMIX

35

100

TAPS ACCESSORIES

AERATOR



**81 A** €1,50  
High technology anti-limestone aerator F22, patented and long-lasting, shell in c.p. brass, internal in innovative plastic material very resistant.



**83 A** €1,50  
High technology anti-limestone aerator M24, patented and long-lasting, shell in c.p. brass, internal in innovative plastic material very resistant.



**83 C** €1,80  
Patented key for the weekly cleaning of the high technology aerators art 81 A and 83 A.



**81** €1,50  
Classic aerator with inox nets, for sink spout F22.



**83** €1,50  
Classic aerator with inox nets, for basin, bidet and sink, M24.



**84** €2,20  
Aerator for bath mixer, M28.



**83 F16** €3,80  
F16 aerator.



**81 SN** €2,70  
Joint F22 and nut M22.



**83 SN** €2,70  
Joint M22 and nut M24.



**83 N41** €3,20  
M18 aerator.



**85** €4,20  
Balljoint aerator for one-hole bidet, M24.



**83 NE SI** €3,40  
Neoperl aerator selfcleaning M24X1 with silicon antilimestone bottom, for soft simplified handcleaning.



**83 NE** €1,80  
Neoperl aerator with built-in effect, with silicon anti-limestone technology for an easier cleaning, M24X1 thread, can be easily substituted to all the standard mixers with M24X1 aerators. Very indicated for design models like Qubika, Minimal, SQ.



**83 NE BA** €3,60  
Neoperl aerator M24X1 with movable aerator bottom that, with the simple touch, permits to move the flow to the preferred direction.



**83 EU** €1,60  
Neoperl aerator M24 coin slot. Installation and removal of the aerator by using a coin placed in the slot.



**83 Z40** €3,90  
Ultra-flat aerator M24, suitable on every wash-basin or sink. Installation and removal with key 83 Z40 C.



**83 Z40 C** €1,80  
Patented key for the weekly cleaning of the high technology aerators art 83 Z40.



## AERATOR: WATER ENERGY SAVING LINE AND ANTI-VANDALISM



**83 AVC** € 4,00

Anti-vandalism and anti-limestone kit, composed by special aerator for wash basin and bidet mixers M24 and assembly, caring and weekly cleaning key, high technology and patented.



**83 SET L6 - 83 SET L8**

Total water saving set, composed by 1/2" shower connection with reduced flow in c.p. brass, wash basin and bidet aerator with reduced flow and assembling, caring and weekly cleaning key, high technology, patented. This set is available with outlet flow of 6 liters by minute (cod 83 SET L6) or 8 liters by minute (cod 83 SET L8).

**83 SET L6**  
€ 11,70

**83 SET L8**  
€ 11,70



**83 L6 - 83 L8**

Aerator for wash basin and bidet mixers, M24, water saving, with reduction of consumption and excellent flow at 6 litres by minute (art. 83 L6) or 8 liters by minute (art. 83 L8).

**83 L6**  
€ 3,30

**83 L8**  
€ 3,30



**83 AVC L6 - 83 AVC L8**

Kit same as 83 AVC, plus water saving, that also includes one reduction of water consumption at 6 liters by minute, art 83 AVC L6, or one reduction of water consumption at 8 liters by minute, art 83 AVC L8.

**83 AVC L6**  
€ 5,80

**83 AVC L8**  
€ 5,80



**309R L6 - 309R L8**

C.p. brass connection, water saving program with flow reduction at 6 liters by minute (art 309 L6) or 8 liters by minute (art 309 L8).

**309R L6**  
€ 4,60

**309R L8**  
€ 4,60



**662 FI 12** € 0,29

1/2" washer with net filter, anti-impurity.



**662 RE 12** € 0,22

1/2" washer, reduced flow, water saving 30%.



## CLEANING KIT WITH AERATOR

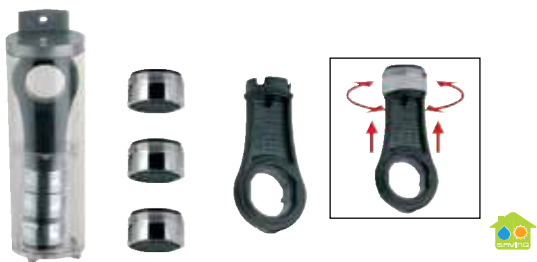

**83 SET 01** € 8,20

Set complete of 3 anti-limestone M24 aerators of high technology + 1 weekly cleaning key, patented and extremely long lasting, all in c.p. brass and innovative plastic material very resistant, packed in a holding hard and transparent tube, suitable to be hung. The key has been studied to clean the aerator in one simple, easy movement.



**83 SET 02** € 8,20

Set complete of 2 anti-limestone M24 aerators of high technology and 1 anti-limestone F22 aerator + 1 weekly cleaning key, patented and extremely long lasting, all in c.p. brass and innovative plastic material very resistant, packed in a holding hard and transparent tube, suitable to be hung. The key has been studied to clean the aerator in one simple, easy movement.



**81 AC** € 2,90

Set complete of 1 anti-limestone F22 aerator of high technology + 1 weekly cleaning key, patented and extremely long lasting, all in c.p. brass and innovative plastic material very resistant. The aerator and the key has been studied to clean the aerator in one simple, easy movement.



**83 AC** € 2,90

Set complete of 1 anti-limestone M24 aerator of high technology + 1 weekly cleaning key, patented and extremely long lasting, all in c.p. brass and innovative plastic material very resistant. The aerator and the key has been studied to clean the aerator in one simple, easy movement.

PROJECT

TEN

GIGA FOUR

KISS

REMIX

35

100

TAPS ACCESSORIES

REDUCTION



**81 RD 12** € 4,40  
Reduction 1/2MxM22. Allows to connect any 1/2F" connection, for example all the shower flexibles, with a standard aerator basin/sink F22, see our art. 81A (instead of the classic handshower or shut-off).



**81 RD 12M 22F** € 4,40  
1/2MxF22 reduction. Connecting any component with 1/2F connection to the washbasin/sink F22.



**83RD 12F 22F** € 4,40  
1/2FxM22 reduction. Connecting any component with 1/2M connection to the washbasin/sink F22.



**83 RD 12** € 4,40  
Reduction 1/2MxF24. Allows to connect any 1/2F" connection, for example all the shower flexibles, with a standard aerator basin/sink M24, see our art. 83A (instead of the classic handshower or shut-off).



**83 RD 12M 24M** € 4,40  
1/2MxM24 reduction. Connecting any component with 1/2F connection to the washbasin/sink M24.



**83RD 12F 24M** € 4,40  
1/2FxM24 reduction. Connecting any component with 1/2M connection to the washbasin/sink M24.



**82** € 2,20  
Double spray aerator, with balljoint shower, thread F22 with reduction M24.



**82 DJ** € 42,00  
Double spray c.p. brass shower-aerator "Dual Jet", with ball-joint shower, thread F22.



**82 UN** € 1,50  
Double spray aerator, with balljoint shower, with standard connection.



**82 L** € 1,80  
Double spray aerator, with screw standard connection, length 15 cm.





**82 LGH** € 2,30  
Double spray aerator, with nut and thread F22, length 15 cm.

ECCENTRICS & CONNECTIONS

- |  |   |   |  |             |             |             |        |        |        |
|--|---|---|--|-------------|-------------|-------------|--------|--------|--------|
| <p><b>89</b></p>  <p>€2,50</p> <p>Eccentric unions for mixers, 1/2 x 3/4, with C.P. brass flange.</p> | <p><b>89 L</b></p>  <p>€3,00</p> <p>Eccentric unions for mixers, 1/2x3/4, with C.P. brass flange, luxury type.</p> | <p><b>89 N</b></p>  <p>€4,50</p> <p>Eccentric unions for mixers, 1/2 x 3/4, with minimal C.P. brass flange.</p> | <p><b>90</b></p>  <p>C.P. brass S-connection for mixers, 1/2x3/4, length 4, 6, 8 cm.</p> <table border="0"> <tr> <td><b>cm 4</b></td> <td><b>cm 6</b></td> <td><b>cm 8</b></td> </tr> <tr> <td>€12,30</td> <td>€13,10</td> <td>€14,00</td> </tr> </table> | <b>cm 4</b> | <b>cm 6</b> | <b>cm 8</b> | €12,30 | €13,10 | €14,00 |
| <b>cm 4</b>  | <b>cm 6</b>   | <b>cm 8</b>   |  |             |             |             |        |        |        |
| €12,30   | €13,10  | €14,00  |  |             |             |             |        |        |        |

VERTICAL CONNECTION FOR BATH MIXER

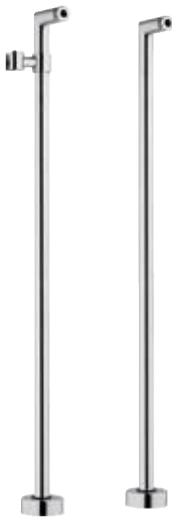
- |   |   |  |
|---|---|--|
|  <p><b>88 01 LI</b></p> <p>CR €312,10</p> <p>Couple c.p. brass vertical connections for bath mixer, serie Liberty, 3/4M x 3/4M.</p> |  <p><b>88 01 LI S</b></p> <p>CR €597,00</p> <p>Couple c.p. brass vertical connections for bath mixer, serie Liberty, with hand shower holder 3/4M x 3/4M.</p> |  <p><b>88 N 02</b></p> <p>CR €402,30</p> <p>Couple c.p. brass vertical connections for bath mixer, serie Minimal, with hand shower holder 3/4M x 3/4M.</p> |
|---|---|--|

- |   |  |  |   |
|---|--|--|---|
|  <p><b>88 UK</b></p> <p>CR €53,30</p> <p>Couple c.p. brass vertical connections for bath mixer, serie UK, 3/4M x 3/4M.</p> |  <p><b>88 LI</b></p> <p>CR €72,30</p> <p>Couple c.p. brass vertical connections for bath mixer, serie Liberty, 3/4M x 3/4M.</p> |  <p><b>88</b></p> <p>CR €18,80</p> <p>C.P. brass vertical connection for bath mixer, 1/2M x 3/4M.</p> |  <p><b>88 BI</b></p> <p>€23,50</p> <p>Vertical connection for bath mixer in white colour, 1/2M x 3/4M.</p> |
|---|--|--|---|

PROJECT

TEN

GIGA FOUR

KISS

REMIX

35

100

TAPS ACCESSORIES

SPOUTS



**86** CR € 10,40  
Lower "S" sink spout, cm 22,5, universal type, with aerator.



**86 N** CR € 9,50  
Lower "S" sink spout, cm 20, with aerator.



**86 N 40** CR € 14,80  
Lower "S" sink spout, cm 40, with aerator.

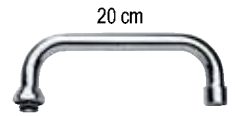

**86 U** CR € 9,50  
Upper "U" sink spout, cm 20, with aerator.



**87 N** CR € 11,30  
"J" spout for one-hole sink mixer, with aerator.



**87** CR € 14,60  
"J" spout for one-hole sink mixer, universal type, with aerator.



**92 C** CR € 26,10  
"C" spout with nut 3/4, with aerator.



**92 CC** CR € 22,60  
"C" spout with nut 3/4, with aerator, short type.



**92 U** CR € 24,50  
"U" spout Ø 22, with aerator.



**93** CR € 53,80  
Casted cm 30 long spout with diverter, with 3/4 nut, with aerator.



**92 16** CR € 16,10  
Straight spout with 3/4 nut, 16 cm long, with aerator.



**92 20** CR € 18,10  
Straight spout with 3/4 nut, 20 cm long, with aerator.



**92 30** CR € 20,30  
Straight spout with 3/4 nut, 30 cm long, with aerator.



**92 40** CR € 37,10  
Straight spout with 3/4 nut, 40 cm long, with aerator.



**92 50** CR € 40,00  
Straight spout with 3/4 nut, 50 cm long, with aerator.

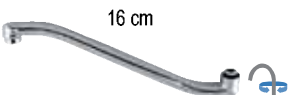

**92 S16** € 18,20  
"S" spout with 3/4 nut, 16 cm long, with aerator.



**92 S20** € 20,50  
"S" spout with 3/4 nut, 20 cm long, with aerator.

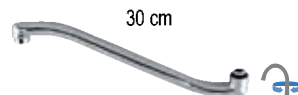

**92 S30** € 23,10  
"S" spout with 3/4 nut, 30 cm long, with aerator.

## SUPPORTS FOR HANDSHOWER

**325 07**  **CR €34,80**  
Support for extensible handshower for deck bath and deck sink, round base model.

**325 S 07**  **CR €31,40**  
Straight support for extensible handshower for deck bath and deck sink, squared base model.

## WASTES

**95 TA**   
C.p. brass plug for pop-up waste for drain 1" and for drain 1" 1/4.  
**1" €3,90**    **1" 1/4 €4,80**

**95 TAG**  **€12,10**  
Big plug in c.p. brass for pop-up waste with drain 1" 1/4.

**95 TAS**  **€20,00**  
Squared big plug in c.p. brass for pop-up waste with drain 1" 1/4.

**96 TA**  **€4,50**  
Chrome plated brass plug for automatic bath waste and overflow.

**BA K10**  **€6,20**  
Base in c.p. brass for mixers like serie Kiss, Ten, Giga.

**94**  **€3,80**  
Rod for pop-up waste, length 30 cm, in c.p. brass.

**95 AC**  **€21,80**  
Rod and flange for bidet for pop-up automatic waste, in c.p. brass.

**95 Q AC**  **€28,50**  
Rod and flange for bidet for pop-up automatic waste, in c.p. brass.

**AS T10**  **€4,80**  
Rod with knob and small joint for Ten series, in c.p. brass.

**AS K10**  **€4,20**  
Rod with knob and small joint for Kiss series, in c.p. brass.

**FIS K10**  **€1,90**  
Fixing set for art. K10, K20, K40.

**FIS R10**  **€2,50**  
Fixing set for art. R10, R20, R40.

**FIS T10**  **€2,40**  
Fixing set with double screw.

**FIS A10**  **€7,20**  
Fixing set for: Atmos, Flash, Qubika Waterfall.

**FIS B10**  **€2,50**  
Fixing set for art. S42 U, S10 G, B10, B20, Q42U, Q10 G.

PROJECT

TEN

GIGA FOUR

KISS

REMIX

35

100

TAPS  
ACCESSORIES

**AUTOMATIC CLICK-CLACK POP-UP WASTES**



**904 CC 2** € 29,90  
Automatic pop-up waste, click-clack system, 1"1/4, big plug, without overflow, model with shorter cup.



**904 CC** € 33,30  
Automatic pop-waste, click-clack system, 1"1/4, big plug, without overflow.



**904 SCC 2** € 37,20  
Squared automatic pop-up waste 1"1/4 with click-clack system without overflow, model with shorter cup.



**904 SCC** € 40,70  
Squared automatic pop-up waste 1"1/4 with click-clack system without overflow.



**905 CC 2** € 29,90  
Squared automatic pop-up waste 1"1/4 with click-clack system with overflow, model with shorter cup.



**905 CC** € 33,30  
Automatic pop-up waste, 1"1/4, click-clack system, big plug, with overflow, model with shorter cup.



**905 SCC 2** € 37,20  
Squared automatic pop-up waste 1"1/4 with click-clack system with overflow, model with shorter cup.



**905 SCC** € 40,70  
Squared automatic pop-up waste, click-clack system, 1"1/4, with overflow.



**906 CC 2** € 26,30  
Automatic pop-up waste, click-clack system, 1"1/4, with overflow, model with shorter cup.



**906 CC** € 29,90  
Automatic pop-up waste, 1"1/4, click-clack system, with overflow.





**907 2** € 40,30  
Automatic pop-up waste 1"1/4 with big plug always opened, and click-clack system for internal cleaning, model with shorter cup.



**907** € 43,70  
Automatic pop-up waste 1"1/4 with big plug always opened, and click-clack system for internal cleaning.

PROJECT

TEN

GIGA FOUR



**905 CCR** € 30,90  
Universal automatic pop-up waste 1"1/4 with click-clack system.



**905 CC XL 114** € 49,20  
Automatic pop-up waste, click-clack system, 1" 1/4, big plug, with overflow, extralong version.

KISS

REMIX

35

100

## POP-UP WASTES



**95** 1" €12,20 1" 1/4 €12,20  
C.P. brass pop-up waste, 1", 1"1/4.



**95 L** 1" 1/4 €15,30  
C.P. brass pop-up waste 1"1/4, luxury type.



**95 U** 1" 1/4 €19,70  
C.P. polished pop-up waste, 1"1/4, luxury type.



**95 UG** 1" 1/4 €23,70  
C.P. polished pop-up waste, 1"1/4, luxury type with big plug covering the drain.



**95 US** 1" 1/4 €38,60  
C.p. polished pop-up waste, 1"1/4, luxury type with big squared flat plug covering the drain.



**95 P** 1" 1/4 €4,30  
Plastic pop-up waste, 1"1/4.



**95 AM** € 25,90  
C.p. waste model America or American, polished and in c.p. brass.

STAINLESS STEEL FLOOR DRAINS



cm 10x10



**913 GVC 10** € 20,00  
Stainless steel floor drain cm 10x10, with fixed grill and movable plug.



**913 GV 10** € 16,50  
Stainless steel floor drain cm 10x10, with fixed grill.

cm 15x15



**913 GVC 15** € 27,60  
Stainless steel floor drain cm 15x15, with fixed grill and movable plug.



**913 GV 15** € 22,60  
Stainless steel floor drain cm 15x15, with fixed grill.



**913 CV 15** € 22,60  
Stainless steel floor drain cm 15x15, with fixed plug.



**913 GFC 15** € 23,60  
Stainless steel floor drain cm 15x15, with movable grill and movable plug.

cm 20x20



**913 GVC 20** € 33,20  
Stainless steel floor drain cm 20x20, with fixed grill and movable plug.



**913 GV 20** € 28,00  
Stainless steel floor drain cm 20x20, with fixed grill.



**913 CV 20** € 28,00  
Stainless steel floor drain cm 20x20, with fixed plug.



**913 GFC 20** € 29,20  
Stainless steel floor drain cm 20x20, with movable grill and movable plug.

ANTI COCKROACH-INSECTS TRAP



**913 PSA 01** € 4,50  
Anti cockroach-insects to use under the floor drains with size cm 15x15 e 20x20.



**913 PSA 02** € 3,60  
Anti cockroach-insects to use under the floor drains with size cm 10x10.

RECTANGULARS FLOOR DRAINS



**913 RG 12**  
Rectangular floor drain, in stainless steel, with drain grill, large 12.5 cm, lengths cm 70, 80, 90, 100, 120.

70	80	90	100	120
€ 548,00	€ 588,00	€ 628,00	€ 668,00	€ 744,00



**913 RP 12**  
Rectangular floor drain, in stainless steel, model for tiling, large 12,5 cm, lengths cm 70, 80, 90, 100, 120.

70	80	90	100	120
€ 548,00	€ 588,00	€ 628,00	€ 668,00	€ 744,00

## STAINLESS STEEL FLOOR DRAIN AND SIPHON



**913 SF 10** € 63,40  
Stainless steel floor drain and siphon, cm 10x10.



**913 SF 15** € 105,60  
Stainless steel floor drain and siphon, cm 15x15.



**913 SF 20** € 132,70  
Stainless steel floor drain and siphon, cm 20x20.

## TRAPS



**977** 1" 1/4 € 21,90  
"P" trap made by tube, in c.p. brass, 1" 1/4".



**977X 114** 1" 1/4 € 15,20  
"P" trap made by tube, in stainless steel, 1" 1/4.

NEW



**970** 1" € 27,60 1" 1/4 € 32,30  
C.P. brass bottle trap, 25 cm outlet tube, 1", 1" 1/4.



**970 Z** 1" 1/4 € 17,80  
Bottle trap in zamac without waste, for wash-basin, 1" 1/4, outlet tube cm 30.



**971** 1" € 28,40 1" 1/4 € 30,80  
C.P. brass "S" trap, 25 cm outlet tube, 1", 1" 1/4.



**971 Z** 1" 1/4 € 14,80  
"S" trap in zamac, 25 cm outlet tube, 1" 1/4.



**972** 1" € 28,80 1" 1/4 € 38,40  
C.P. brass "U" trap, 25 cm outlet tube, 1", 1" 1/4.



**973 Z** 1" 1/4 € 23,40  
Bottle trap in zamac with waste, for wash-basin, 1" 1/4.



**968**  
C.P. brass reduction for trap 1" M x 1" 1/4 F, 1" 1/4 M x 1" 1/2 F.

1" M x 1" 1/4 F € 3,70  
1" 1/4 M x 1" 1/2 F € 4,40



**969**  
C.P. brass reduction for trap 1" 1/4 M x 1" F, 1" 1/2 M x 1" 1/4 F.

1" 1/4 M x 1" F € 4,40  
1" 1/2 M x 1" 1/4 F € 4,20

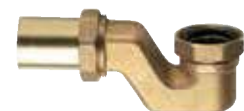

**98** € 26,30  
Heavy trap in casting brass, with nut 1" 1/2 for bath waste and overflow.

PROJECT

TEN

GIGA FOUR

KISS

REMIX

35

100

TAPS ACCESSORIES

SIPHONS



**958 L** € 55,40  
C.P. brass "MINIMAL" P trap, for wash-basin, 1"1/4, outlet tube cm 30 and heavy flange.



**958 B** € 49,20  
C.P. brass "MINIMAL" P trap, for bidet, 1"1/4, outlet tube cm 30 and heavy flange.



**965** € 53,50  
C.p. brass hexagonal P trap, 1"1/4, outlet tube cm 30 and heavy flange.



**960** € 66,40  
C.p. brass SQ trap, 30 cm outlet tube, 1"1/4, with heavy squared wall flange.



**956** 1" € 25,80 1" 1/4 € 44,80  
C.P. brass luxury "P" trap, heavy type, 1", 1" 1/4, outlet tube cm 30.

SAVE-SPACING SIPHONS



**985** € 189,00  
Save-spacing siphon with click-clack built-in drain with overflow, round, chrome.



**984** € 189,00  
Save-spacing siphon with click-clack built-in drain without overflow, round, chrome.



**985 S** € 195,00  
Save-spacing siphon with click-clack built-in drain with overflow, squared, chrome.



**984 S** € 195,00  
Save-spacing siphon with click-clack built-in drain without overflow, squared, chrome.

## BATH WASTES



PROJECT



**96 P** € 35,50  
Plastic combined bath waste with automatic pop-up with external wire.

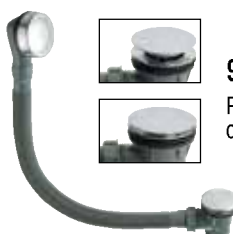

**96 PCC** € 38,80  
Plastic combined bath waste and overflow, "click-clack" waste system.

TEN

GIGA FOUR



**96 LI CC** € 268,30  
Bath brass waste with siphon, trap, chromated copper tube and click clack waste, all in chrome plated.



**96 LI T** € 203,00  
Bath brass waste with siphon, trap and chromated copper tube, all in chrome plated.

KISS

REMIX



**96** € 62,30  
C.P. brass automatic bath waste and overflow with external wire and copper tube.



**96 CC** € 53,50  
C.P. brass waste and overflow with copper tube and "click-clack" waste.

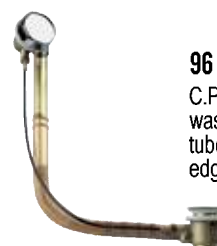

**96 VA** € 74,10  
C.P. brass automatic bath waste, overflow and copper tube, cm 70, for bath tube edge.

35

100

TAPS  
ACCESSORIES



# DISPLAYERS

## FLOOR DISPLAYERS



ESP Q € 650,00



ESP VERT € 336,00

## AMBIENT MIXERS DISPLAYER



ESP AMB



€ 158,00



ESPLT 72

€ 498,60

Faucet with Touch-Me technology for demonstration purpose. In all the situations where it's not possible to connect the Touch faucet to the water supply, this DEMO version can simulate, when touching the mixer, the exact on/off of the water by turning on/off a blue light positioned in a very visible area by the aerator. The item is reprocessed for demonstration only.

## SALE CONDITIONS

### Orders acceptance

The order is always subject to approval by the seller.

### Delivers

The goods are delivered Ex Works and travel at the buyer's own risk. The seller reserves the right to execute partial consignments.

### Forwarding

The quantities must be checked on receipt of the goods and any complaint must be made to the carrier. Any additional cost applied by the carrier will be charged to the buyer.

### Packing

The goods are packed in standard packing on pallets charged to the customer.

### Delivery terms

The delivery terms are always given as information and they never have to be considered as binding.

### Prices

The prices shown on price list are not binding. Remer Rubinetterie S.p.A. reserves the right to modify the sales prices in any time with no prior warning.

### Payments

Interest at the current rate will be charged for any delays in payment. Remer Rubinetterie S.p.A. reserves the right to delete any order on hand if the payments are not correct. Any complaint of whatever type or value do not give the right to suspend payments.

### Complaints

Complaints and returned goods cannot be accepted after a period of 7 days from the arrival of the goods. Complaints must be made by mean of a registered letter or by fax within the terms stated. Any return of the goods must be authorized in advance by Remer Rubinetterie S.p.A. with instructions about it.

### Technical specifications

Remer Rubinetterie S.p.A. reserves the right to carry out technical and aesthetical changes without previous notice.

### Lien

The products remain the property of Remer Rubinetterie S.p.A. until the cost has been paid in full, in accordance with the provisions of the C.C.

### Liability

Remer Rubinetterie S.p.A. does not provide a guarantee covering the incorrect or the inappropriate use of its products. If the material should be substandard owing to manufacturing faults which are technical inspections, Remer Rubinetterie S.p.A. reserves the right to replace the material or to credit the value to the buyer. However under no circumstance does the company's liability extend to the payment of direct or indirect charges for other things.

### Competent Court of Law

For any controversy that may arise the competent court of law is the one of Milan.

Printed on August 2018

Remer Rubinetterie S.p.A. reserves the right to introduce technical and aesthetical changes on all the articles, without previous notice to the customer.









**Remer Rubinetterie S.p.A.**  
 Via Leonardo da Vinci, 83  
 20062 Cassano d'Adda (MI) Italy  
 Tel. +39 0363 364 211  
 E-Mail: [info@remer.eu](mailto:info@remer.eu)  
[www.remer.eu](http://www.remer.eu)

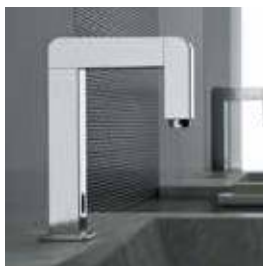
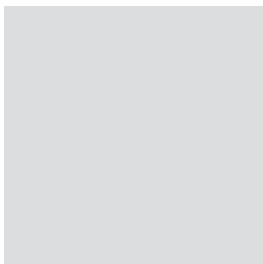

**Ufficio Commerciale Italia:**  
 Tel. 0363 364 333  
 Fax 0363 63 575  
**Export Commercial Department:**  
 Tel. +39 0363 364 364  
 Fax +39 0363 364 300

